



# SOLUTIONS

VOLUME 32 | 2016

PAGES 32-37

NEW  
Kreg



CLAMPING SOLUTIONS

PAGES 48-52

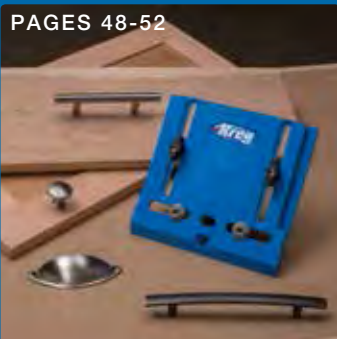

HARDWARE SOLUTIONS

PAGE 21



STORAGE SOLUTIONS



INTRODUCING THE  
MOBILE PROJECT CENTER

PAGES 54-55





Welcome to the 32nd edition of the Kreg® Tool Company catalog. We're confident you're going to find it filled with interesting items that will help you as you build projects with wood. Why? Because we know you're passionate about building. And we're just as passionate about creating solutions that help you build faster, better, and smarter.

Whether you're just getting started or you've been at it for years, you'll find a Kreg product that suits your needs. Of course, you'll see our well-known Kreg Jigs® that put professional joining capability in your hands. But you'll also find that we offer a wide array of solutions for measuring and marking, cutting, clamping, joining, routing, hardware installation, creating a workspace, and even apparel and education materials. You'll definitely want to take a look at our cool new products, too. We're positive that some of them, such as our innovative Hardware Installation Jigs and our Mobile Project Center, will actually change the way you build—just like the Kreg Jig® has done for so many over the past three decades.

Of course, we know that tools and products are important, but we know that creating high-quality projects requires more than great tools. That's why we're dedicated to offering additional solutions that you may not find listed on catalog pages with an item number—but you will find information about them on pages 58 and 59. After all, everyone can use a little help getting started, or with growing skills they already have. So we offer a wealth of free educational resources that you can use. Our newsletters, the Kreg YouTube channel, and our online Kreg Owners' Community all offer great information. Plus, we're proud to have launched BuildSomething.com®—our online community for passionate project builders. It's a great source for free step-by-step project plans, and a fun place to connect with other builders. By the way, you won't find prices for these resources listed in the catalog either. They're all free.

Have fun looking through this catalog. We're confident that you'll find solutions for the challenges you face on your building journey. Whether you buy from us today, next week, or never, though, we want you to know that we're here with many ways to help you turn your passion into projects you'll be proud of.



**Hardware Containers and Screw Organizer**  
(page 21)

**Kreg Clamps with Automaxx® Technology**  
(pages 31-37)

**Hardware Installation Jigs**  
(pages 48-52)

**Mobile Project Center**  
(pages 54-55)



4

### MEASURING AND MARKING SOLUTIONS

Layout Tools | Adhesive Tapes



6

### CUTTING SOLUTIONS

Saw Attachments | Saw Accessories



13

### JOINING SOLUTIONS

Foreman | Kreg Jigs® | Kreg® Screws  
Kreg Plugs | Kreg Jig® Accessories  
Deck Jig™ & Accessories  
Pocket-Hole Machinery



32

### CLAMPING SOLUTIONS

Project Clamps | Bench Clamps  
Bench Clamp Systems | Clamp Vise  
Right Angle Clamp | Classic Face Clamps  
Corner Clamp Bar Clamps | Clamp Accessories



40

### ROUTING SOLUTIONS

Router Table System | Benchtop Router Table  
Router Table Insert Plates | Routing Accessories  
Beaded Face-Frame System



48

### HARDWARE INSTALLATION SOLUTIONS

Cabinet Hardware Jig | Concealed Hinge Jig  
Shelf Pin Jig | Drawer Slide Jig



53

### WORKSPACE SOLUTIONS

Mobile Project Center | Universal Bench

ITEM# CATALOG-32 | August 2016  
Replaces all previous catalogs | Product offering subject to change without notice.



# MEASURING AND MARKING SOLUTIONS



Layout Tools 5  
 Adhesive Tapes 5

## Multi-Mark™ ITEM# KMA2900

### Simplify Measuring and Layout Tasks

The Multi-Mark™ is an incredibly handy multipurpose marking and measuring tool, perfect for a wide variety of household and job-site applications. The Multi-Mark™ features three scale configurations, a built-in level, a 3/16" (5mm) reveal gauge, and much more. Whether you need to transfer a measurement, lay out mitered corners, or align and straighten a few picture frames, the Multi-Mark™ is the only tool you'll need to get the job done.

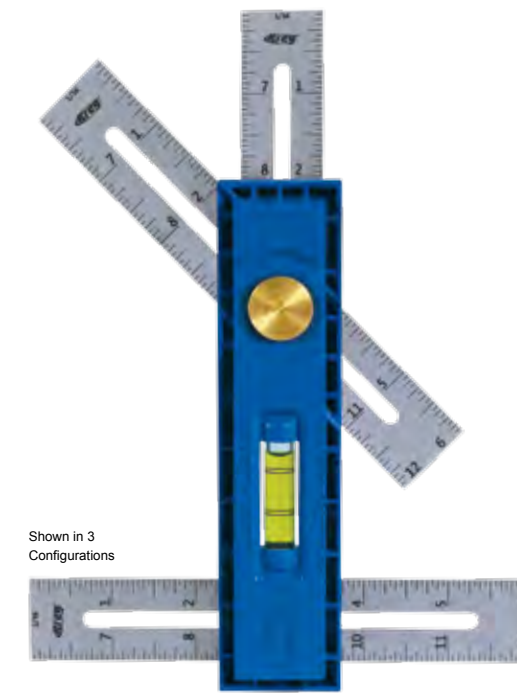

Shown in 3 Configurations

### HUNDREDS OF USES

The Multi-Mark™ doesn't know the meaning of the term 'single-purpose.'



Lay Out Mitered Corners



Set 3/16" (5mm) Reveals



Transfer Measurements



Align / Square Your Projects



Set Bit / Blade Heights



Level Your Work

### Adhesive Tapes

## Measuring Tapes

### Imperial 12' Self-Adhesive Tape (3658mm)

This 1/2" (12mm) wide, self-adhesive measuring tape fits snugly into the recess on the top edge of our Top Trak and Heavy-Duty Trak. Metallic tape is highly scuff-resistant and can be trimmed to length with a scissors.



#KMS7723 Tape (12' R-L reading) (3658mm)  
 #KMS7724 Tape (12' L-R reading) (3658mm)

### Metric 3.5-Meter Self-Adhesive Tape (3500mm)

Metric 3.5 (3500mm) meter tape is self-adhesive and fits snugly into the recess on the top edge of our Top Trak and Heavy-Duty Trak. Metallic tape is highly scuff-resistant and can be trimmed to length with a scissors.



#KMS7728 Tape (3.5-meter, R-L reading) (3500mm)  
 #KMS7729 Tape (3.5-meter, L-R reading) (3500mm)



# CUTTING SOLUTIONS



## Rip-Cut™ ITEM# KMA2675

### Make Straight and Accurate Rip Cuts with your Circular Saw

The Rip-Cut™ speeds and simplifies the process of ripping down large plywood and MDF panels. There is no need for measuring, marking, or chalk lines. The Rip-Cut™ quickly and easily attaches to almost any circular saw, letting you cut pieces up to 24"-wide (610mm) with great accuracy.

The Rip-Cut™ features a durable design that includes a solid aluminum guide rail, an easy-to-read adjustable scale, and a reversible guide arm that works whether you're left- or right-handed, and whether your blade is on the left or right side of the saw. It's an incredibly easy, precise, and affordable way to break down large panels for almost any project.



The Rip-Cut™ makes it easy to achieve straight, accurate, repeatable cuts using an ordinary circular saw.

Materials	Aluminum Guide Rail Size:	Saw Sled Size:	Cut Width:
High-quality aluminum, impact-resistant plastic polymer	3" wide x 30" long (7.6mm x 76mm)	6½" x 8½" (165mm x 216mm)	Up to 24" (610mm)

- A** The Rip-Cut™ quickly and easily connects to almost any circular saw—left or right blade. It's easy to use, whether you're left- or right-handed.
- B** No table saw? No problem. The Rip-Cut™ has a 24" capacity, meaning you can rip a 4'x8' sheet of plywood in half.



- C** The Rip-Cut™ guide arm supports your blade throughout the cut – reducing blade wander for straight, accurate results.
- D** After you rip your sheet, you can use the Rip-Cut™ to break your material down into smaller pieces, too.

Saw Attachments	7-10
Trak Components	10
Saw Accessories	11-12



## Precision Band Saw Fence

ITEM# KMS7200

### A New Level of Band Saw Accuracy

Most band saw blades don't run perfectly perpendicular to the front of your table. There's always just a little bit of "drift" that prevents you from getting precise cuts, even with a fence. The Precision Band Saw Fence easily adjusts to your blade's drift angle to provide you with a new level of band saw accuracy. This fence mounts to most 14" (355mm) band saws right out of the box, and can be modified to fit many others by drilling a single hole in the aluminum mounting rail.



Compensate for blade drift by loosening two hex bolts and adjusting the angle of the fence.



Add a stop to the fence for repeat cuts to a set depth, such as cutting tenons.

#### Unmatched Versatility

Never before has a band saw fence allowed you to accomplish such a wide variety of cuts. This fence adjusts both for blade drift and for perpendicularity to the blade (essential when cutting thin veneers). In addition, the fence can be removed and reassembled in a low-profile orientation to allow the guide blocks to be moved closer to the workpiece. Last but not least, the fence accepts our resaw guides and our stops for use in additional applications.



Fence	Precision Lens Cursor	Blade Drift	Dimensions	Finish	Adaptability
Aircraft-grade aluminum	Allows precise cuts	Two simple adjustments for blade drift	Mounting Rail is 26" (660mm) long Fence is 18" (457mm) long	Anodized for easy cleanup	Pre-drilled holes on the mounting rail fit most 14" (355mm) band saws

#### A RIGID DESIGN

The aluminum fence is incredibly strong, straight, and built to last for years. The face and top edge of the fence contain T-slots for adding stops, resaw guides, and more.

#### B EASY TO REMOVE

When you don't need the fence, remove it in seconds – no tools required! Just loosen the locking knob and lift the fence from the mounting rail. The rail sits below your table's surface to stay out of the way.



#### C PRECISION LENS CURSOR

Magnified and easy-to-read for even the smallest adjustments, the thin red line on the Precision Lens Cursor lets you accurately set up the fence for cutting veneer, tenons, and more.



#### D ADJUSTABLE IN 2 DIMENSIONS

This fence adjusts to set up perfectly square to your table and blade. Two simple adjustments allow you to set the fence to match blade drift, greatly enhancing cutting accuracy.

### RECOMMENDED ACCESSORIES



**4.5" Resaw Guide (114mm)**  
Adjust for blade drift as you cut.

ITEM# KMS7213



**7" Resaw Guide (178mm)**  
Adjust for blade drift as you cut with wide workpieces.

ITEM# KMS7214



**Precision Micro-Adjuster**  
Add enhanced precision to every cut.

ITEM# KMS7215

## Precision Trak & Stop Kit

### Take the Guesswork Out of Making Accurate and Repetitive Cuts

Take the guesswork, and your tape measure, and pencil out of cutting wood to length. Our Precision Trak and Stop Kit allows you to turn a miter saw into a precise cutting system. Simply position the stop at the dimensions you'd like to cut using the Precision Lens Cursor, place the board against the stop, and cut to that exact length every time. You build the support wings out of plywood (or another sheet material), and then add the Trak. The 2' (610mm) long Trak sections give you options. Includes four 2' (610mm) long sections that can be used on the right or left side of the saw, or split between both sides. Outfitting your saw to cut perfectly-sized workpieces couldn't be simpler!



ITEM# KMS8000



#### Includes:

Four 2' (610mm) pieces of Trak, one Swing Stop™, one Production Stop, one 12' (3675mm) length of L-R reading self-adhesive tape, one 12' (3675mm) length of R-L reading self-adhesive tape, detailed instructions, and mounting hardware.

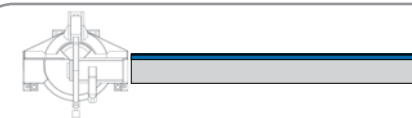

Position all 8 feet (2440mm) of Trak on one side.

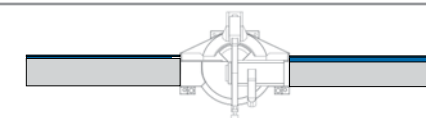

Center your saw with 4 feet (1220mm) of Trak on each side.

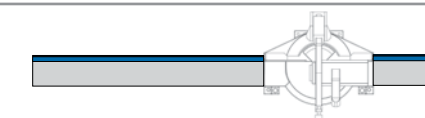

Place 6 feet (1830mm) of Trak on one side and 2 feet (610mm) on the other side.

#### Perfect for a Wide Variety of Applications

The most common setup for the Precision Trak & Stop Kit is with a miter saw. But, many people find it useful to add to their radial arm saw or drill press. No matter where you use the Precision Trak & Stop Kit, you'll find it far more accurate and much quicker than a tape measure and pencil.



### FEATURES

#### A PRODUCTION STOP

Designed to stand up to the rigors of repetitive cuts in an industrial environment, the Production Stop mounts onto the top of the fence and features dual lens cursors for convenient use on either side of the blade.

#### B SWING STOP™

Our innovative Swing Stop™ features specially designed bushings that actively reduce 'play' in the stop, dramatically increasing accuracy. The stop itself easily sets the distance between the end of the board and the saw blade for cutting accuracy and repeatability... and flips out of the way when not in use.



#### C RIGID ALUMINUM FENCE

Incredibly strong and built to last, our anodized aluminum Trak features an L-shaped foot that makes alignment and mounting to any 3/4" (19mm) thick board a snap. Trak is designed with a groove across the top to accept the included self-adhesive measuring tape.



#### D SHOP-MADE SUPPORT WINGS

Build simple plywood or MDF extensions to match the height of your saw, then add a back fence that reaches 2 1/4" (57mm) above the saw height. Instructions and mounting hardware for the Trak are included.



## Precision Stops



### PRODUCTION STOP ITEM# KMS7800

Built for rugged use. Dual lens cursors allow for use on either side of the blade. Fits on top of the Top Trak and Heavy-Duty Trak. Can be removed and repositioned easily.



### SWING STOP™ ITEM# KMS7801

Add repeatable accuracy to your miter saw, band saw, table saw fence, router table, and more with this versatile Swing Stop™. It holds your desired measurement precisely, and swings out of the way easily when you want to cut without it.

## Trak Components

### Jig and Fixture Bar

Six nylon screws along the length of the bar adjust with the turn of a screwdriver to take up any play in the table slot. Mounting holes are located every 4" (101mm) along the length of the bar. Perfect for building workshop jigs and fixtures.

#KMS7303 Jig & Fixture Bar (30") (762mm)



### Combo-Trak

Building your own router table? This combination Miter-Trak and Mini-Trak works with your miter gauge, featherboards, and other accessories to add flexibility to your table top.

#KMS7448 Combo-Trak (48" length) (1219mm)



### Mini Trak 48" (1219mm)

Mini Trak can be used to produce countless types of woodshop jigs and fixtures such as taper jigs and cut-off sleds. An adaptation of our other popular styles of Trak, Mini Trak features a T-slot that captures the head of a standard 1/4" (6mm) hex bolt.

#KMS7509 Mini-Trak (48" length) (1219mm)



### Heavy-Duty Trak

Our Heavy-Duty Trak is an L-shaped, anodized-aluminum extrusion that is extremely straight and perfect for heavy-duty commercial applications. Contains four T-slots that accommodate the head of a standard 1/4" (6mm) bolt.

#KMS7704 Heavy-Duty Trak (4' length) (1219mm)



### Top Trak

This track features a self-aligning L-shaped mounting foot for easy installation to a shop-made fence. Just drill 3/8" (3mm) holes through the back of the extrusion and secure with the included mounting screws.

#KMS7712 Top Trak (2' length) (610mm)

#KMS7714 Top Trak (4' length) (1219mm)

### Trak Clamp

This inexpensive and versatile clamp works great in a variety of applications. Fits the Mini Trak, Top Trak or HD Trak. You may also mount the clamp to a piece of wood by drilling a 1/4" (6mm) hole and then countersinking a 3/16" (11mm) hole on the underside for the bolt head.

#KMS7511 Trak Clamp



## Square-Cut™

ITEM# KMA2600

### Straight, Square Crosscuts, Every Time

The Square-Cut™ allows you to quickly and accurately crosscut boards up to 12" (305mm) wide. Whether you're using a circular saw or a jigsaw, you'll get great results every time. Simply position the Square-Cut™ against the edge of your board and its built-in guide arm ensures that it sits perfectly square. Plus, the guide arm is adjustable, so you can set it to match the offset between the edge of the saw base and blade. With the Square-Cut™, you'll get perfect crosscuts every time.



### ANY MATERIAL UP TO 12" (305mm) WIDE

The extended body on the Square-Cut™ allows it to work effectively with stock up to 12" (305mm) wide, making it perfect for use with siding, deck boards, and more. In addition, a built-in roof pitch layout tool makes quick work of cutting siding, fascia, and rafters on the job site.

## Crown-Pro™

ITEM# KMA2800

### Crown Molding, Simplified!

Installing crown molding is one of the best ways to add instant value to your home. The Crown-Pro™ simplifies the most frustrating steps of the process, so you make fewer mistakes and get the job done faster. This uniquely-designed tool holds your trim at the exact angle required, eliminating the need for advanced compound miter cuts and difficult "coping." Its design lets you compensate for a wide variety of crown molding spring angles, and extension arms lets you work with crown up to 5 1/2" (140mm) wide.

#### Includes:

Comes with everything you need to get started: (1) Crown-Pro™, double-sided Angle Finder, rubber feet, and Owner's Manual. You can also find a helpful crown-installation video on the Kreg YouTube channel.



Size	Max Workpiece Width	Spring Angle Range
3.14" x 14.94" x 4.17" (80mm x 380mm x 106mm) (H x W x D)	5 1/2" with 12" saw, 3 1/2" with 10" saw 140mm w/305mm saw, 89mm w/254 saw	30° - 65°

#### Simple Steps to Perfect Crown:



##### Find Your Angles:

Use the Angle Finder to determine the correct spring angle of your crown molding, and the wall angle.



##### Set Your Angles:

Set your Crown-Pro™ to match your spring angle of your molding, and set your saw to match the wall angle.



##### Make Your Cuts:

Position your Crown-Pro™ on either side of your saw based on the type of joint, and then make cut.



##### Install Your Crown:

Position your crown on the wall and nail it securely into place. You'll get perfect results with the Crown-Pro™.



# Precision Miter Gauge

ITEM# KMS7102

## Adjustable Cutting Accuracy with Simplicity and Durability

Why spend your time calibrating a miter gauge when you can get factory-calibrated accuracy right out of the box? Our Precision Miter Gauge requires no calibrating, and features positive stops at 0°, 10°, 22½°, 30° and 45°, making it easy to cut miters quickly.

When you want to cut a different angle, the easy-to-use Vernier scale allows for fast adjustments to 1/10<sup>th</sup> of a degree.

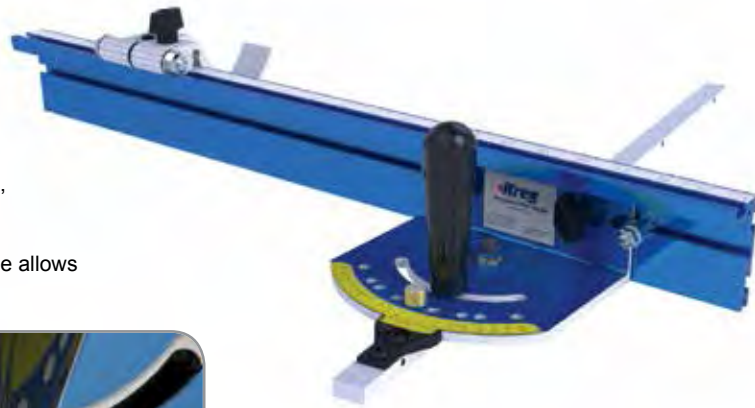

Vernier Scale adjusts to 1/10<sup>th</sup> of a degree.

### Perfect Miters, Fast!

Precision is the name of the game for this CNC-milled miter gauge. We build accuracy into every feature of this product from the adjustable miter bar to the easy-to-use, incredibly accurate Vernier scale. With all of its great features, this miter gauge will give you better, more accurate cuts to ensure project success.

### BUYING OPTIONS

#### Precision Miter Gauge

Precision Miter Gauge only.



ITEM# KMS7101

#### Precision Miter Gauge System

Precision Miter Gauge, 24" (610mm) aluminum fence, and Swing Stop™.



ITEM# KMS7102

Fence	T-Slot bar	Positive Stops at	Vernier Scale	Finish	Calibration
24" (610mm) aircraft-grade aluminum fence	24" (610mm) long, 3/8" (9mm) thick x 3/4" (19mm) wide	0, 10, 22½, 30 & 45 degrees	Adjusts to 1/10 <sup>th</sup> degree	Anodized for easy clean-up	Factory-calibrated right out of the box

### FEATURES

#### A PRECISION LENS CURSOR

Similar to the type of lens found on a quality table saw rip fence, the clear lens features a high-visibility red line that makes it easy to set the Swing Stop™ for precise cuts, time after time.

#### B NO PLAY IN THE MITER SLOT

Our extremely straight 24" (610mm) anodized-aluminum bar is 3/8" (9mm) thick by 3/4" (19mm) wide and features five bar adjusters that eliminate "play" in the miter slot with the turn of a screw driver.

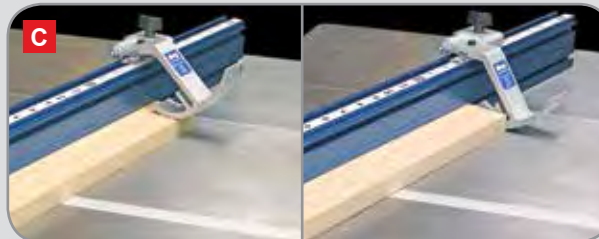

#### C SWING STOP™

Adds repeatable accuracy to your Miter-Gauge fence. This versatile Swing Stop™ holds your desired measurement precisely, and swings out of the way easily when you want to cut without it.



## JOINING SOLUTIONS

Kreg Foreman & Kreg Jigs®	14-19
Kreg® Screws	20-22
Kreg® Plugs	22
Kreg Jig® Accessories	23-24
Deck Jig™ & Accessories	25-26
Pocket-Hole Machinery	27-31



# Foreman

ITEM# DB210

## A Professional-Grade Pocket-Hole Machine at a Consumer-Friendly Price

The Foreman Pocket-Hole Machine from Kreg® offers all of the features and capabilities of our professional-grade machines in a tool that's versatile, portable, and extremely affordable. From contactors and cabinet shops to dedicated hobbyists, the Foreman DB210 is perfect for anyone who is serious about pocket-hole joinery. In no time, you will be building with twice the speed and half the effort of a standard pocket-hole jig.

With the Foreman, a simple squeeze of the trigger and pull of the handle starts the motor, clamps your workpiece, and drills a perfect pocket hole. The adjustable fence positions the workpiece for precise pocket depth, and a pair of adjustable stops provide repeatable accuracy. Built-in dust collection minimizes the mess and speeds the drilling process.

A 110-volt motor enables fast drilling, and a quick-change chuck allows for fast, tool-free bit changes. Plus, the Foreman creates all three types of Kreg® pocket holes: Standard, Micro-Pocket™, and HD (Heavy-Duty). Micro and HD Bits and bushings sold separately.

### Includes:

Foreman Pocket-Hole Machine, adjustable fence with spring-loaded stops, dust-collection attachment, Kreg® stepped drill bit and drill guide, drill bit setting block, 6" (152mm) square-drive bit, and owner's manual.



Motor	Drill Bits	Cycle Time	Material Clamping Capacity	Hole Centering Capacity	Weight	Dimensions	Warranty
110-volt	Comes with standard Kreg® stepped drill bit. Also accepts Kreg® Micro and HD drill bits.	1 second	1½" (38mm)	½" (12mm) material to 1½" (38mm) material	approx. 20 lbs.	Tabletop: 14" (355mm) x 23½" (597mm) Entire Unit: 15"H x 19"L x 29.5"D (380mm)H x (482mm)L x (750mm)D	1 Year Limited Warranty

### Standard Foreman Bit

Keep a standard replacement bit on hand, just like the ⅜" (10mm) diameter bit that comes with your Foreman. This hex-shank bit also works with Kreg Jigs®.



Standard Replacement Bit without Drill Guide  
ITEM# QUIK-BIT

### HD Accessories

HD—the accessory to have when you want to BUILD BIG! You can build outdoor projects, construct strong deck rails, and even frame walls. Coated #14 screws create super-strong joints. You'll need the bit and drill guide to get started. Replacement bit is also available.



HD Drill Bit with Drill Guide  
ITEM# DB210-HDBB



HD Replacement Bit without Drill Guide  
ITEM# DB210-HDB

### Micro Accessories

Micro—great when you want the smallest pocket joint possible. Perfect for adding detail, building cabinet frames, doors and drawers, and for smaller projects. You'll need the bit and drill guide to get started. Replacement bit also available.



Micro Drill Bit with Drill Guide  
ITEM# DB210-MBB



Micro Replacement Bit without Drill Guide\*  
ITEM# KJD/MICROBIT  
\*includes depth collar

# Kreg Jig® K5

ITEM# K5

## Our Most Advanced Kreg Jig® Yet!

The Kreg Jig® K5 incorporates the best features of every Kreg Jig® that came before with upgrades you've never seen.

### Includes:

Kreg Jig® K5 base with ratcheting front-side clamp, extension wings, swiveling dust-collection port, Drill Guide Block, spacer block, workpiece stop, drill bit setup block, stepped drill bit, 6" (152mm) driver bit, stop collar, hex wrench, starter Kreg® screw set, starter pocket-hole plug pack, owner's manual, online SkillBuilder videos, and three downloadable project plans.

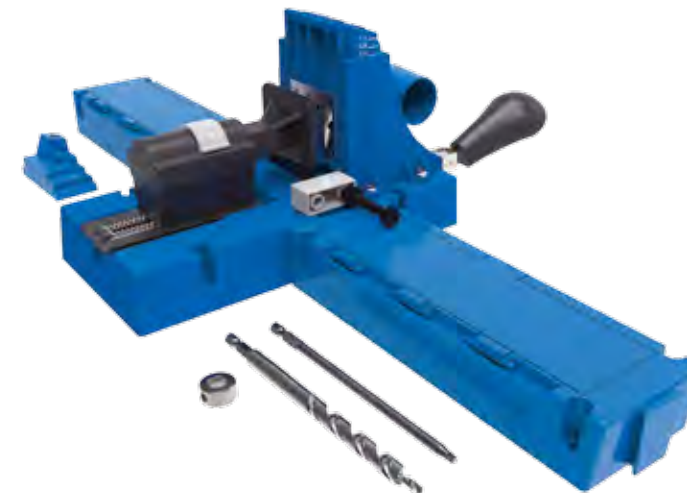

### Easy Thickness Adjustment

The Kreg Jig® K5 offers our simplest workpiece clamping system ever. The ratcheting clamp simply slides into place against your workpiece. Then, you lift the handle until you hear and feel two "clicks", and that's it. Now your clamp is set until you change to a different thickness.



### Support, Plus Onboard Storage

Two large support wings can be attached quickly and easily to the sides of the base. This way, long workpieces get solid footing and won't tip. Plus, there's a large storage compartment under the lid in each wing where you can keep your Kreg bits, screws, and accessories close at hand, but out of the way.



### Swiveling Dust Collection Port

The Kreg Jig® K5 comes with a detachable dust port that swivels from side to side so that you can position it exactly where you want it, and then attach it to a standard 1½" (32mm) vacuum hose. This keeps your work area free of chips and debris, makes drilling easier, and prolongs drill bit life by reducing heat.



### Use for Repairs

The removable Drill Guide Block in the Kreg Jig® K5 makes it easy to use portably, and for making household repairs. Just slip the drill guide out of the Jig, and it can then be clamped in place on a workpiece. Kreg Joinery™ is perfect for repairing broken drawers, beat up bookcases, wobbly chairs, fractured frames, and so much more—without messy glue or nails. You'll be amazed how easy it is to fix what you have, instead of having to replace it.

Body Material	Number of Drill Guides	Drill Guide Spacings	Clamping Method	Workpiece Thickness Settings
Glass-Filled Nylon	3	⅜", 7⁄8", 1½" (14mm, 22mm, 36mm)	Ratchet Clamp on Benchtop Base	½", 5⁄8", ¾", 7⁄8", 1", 1½", 1¾", 1⅞", 1½" (12mm, 16mm, 19mm, 22mm, 25mm, 28mm, 31mm, 35mm, 38mm)

## MAKE IT A MASTER SYSTEM

# Kreg Jig® K5 Master System

ITEM# K5MS

Make your Kreg Jig® K5 even better by upgrading to a Master System

### Includes:

- Kreg Jig® K5
- Extension Wings with Storage
- Adjustable Workpiece Stop
- Stop-Collar Setting Block
- Stepped Drill Bit & 6" Square-Drive Bit
- Screw Selection Chart
- Starter Screw & Plug Set
- 3" Wood Project Clamp
- Portable Base
- Downloadable Project Plans



### INCLUDES THESE PREMIUM ACCESSORIES:



3" Wood Project Clamp



Portable Base

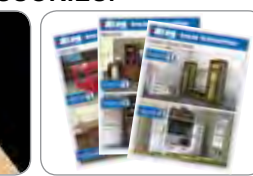

3 Downloadable Project Plans



# Kreg Jig® K4

ITEM# K4

## The Easy Way to Create Rock-Solid Joints That are Built to Last

The Kreg Jig® K4 is the perfect choice for do-it-yourselfers and anyone new to Kreg Joinery™. Whether you're building your first set of shelves, custom wood furniture, or making minor repairs around the house, the Kreg Jig® K4 can help you finish the job in less time, and with far less effort than you ever thought possible.

### Includes:

Kreg Jig® K4, 3/8" (10mm) stepped drill bit, 6" (152mm) square driver, starter Kreg® Screw set, starter pocket-hole plug set, and owner's manual.



Body Material	Number of Drill Guides	Drill Guide Spacings	Clamping Method	Workpiece Thickness Settings
Glass-Filled Nylon	3	3/16", 7/8" and 1 1/8" (14mm, 22mm, 36mm)	Toggle clamp for benchtop applications. Works with a variety of common clamps for repair applications.	1/2", 5/8", 3/4", 7/8", 1", 1 1/8", 1 1/4", 1 3/8", 1 1/2" (12mm, 16mm, 19mm, 22mm, 25mm, 29mm, 31mm, 35mm, 38mm)

### FEATURES

#### 3-HOLE DRILL GUIDE

The 3-hole Drill Guide lets you make perfectly-placed pocket holes in a wide variety of material widths and thicknesses, from 1/2" (12mm) to 1 1/2" (38mm), in 1/8" (3mm) increments.



#### LARGE CLAMPING RECESS

The large clamping recess makes it easy to secure your jig to your workbench using Kreg® multipurpose Face Clamps or any common bar clamp or C-clamp.



#### REMOVABLE DRILL GUIDE

The removable Drill Guide Block in the Kreg Jig® K4 makes it easy to use portably, and for making household repairs. Kreg Joinery™ is perfect for repairing broken drawers, beat up bookcases, wobbly chairs, fractured frames, and so much more.



### MAKE IT A MASTER SYSTEM

# Kreg Jig® K4 Master System

ITEM# K4MS

Make your Kreg Jig® K4 even better by upgrading to a Master System.

### Includes:

- Kreg Jig® K4
- Stepped Drill Bit & Stop Collar
- 6" Square-Drive Bit
- Starter Screw & Plug Set
- Classic 3" Face Clamp
- Portable Base
- Spacer Block
- Material Support Stop
- Dust Collection Attachment



### INCLUDES THESE MUST-HAVE ACCESSORIES:



Material Support Stop

Dust Collection

Classic 3" Face Clamp

Portable Base

# Kreg Jig® R3

ITEM# R3

## The Portable Pocket-Hole Powerhouse

The Kreg Jig® R3 is the perfect solution for any homeowner who builds projects with wood. With the Kreg Jig® R3, you can make home improvements, build bookcases and shelves, create storage projects, make lasting repairs, and much more.

### Includes:

Kreg Jig® R3, clamp adapter, stepped drill bit, 6" (152mm) driver bit, depth collar, hex wrench, starter Kreg® Screw set, starter pocket-hole plug set, and owner's manual, all inside of a compact and durable carrying case.



### Compact Design Makes the Kreg Jig® R3 The Perfect Tool for Repairs

Have a wobbly table or chair at home? You can pry it apart, glue, clamp, and reassemble it, hoping it holds up... Or, you can tighten it in a snap with the Kreg Jig® R3. Small enough to fit just about anywhere, you can use it to fix chair runners, secure table rails to legs, and much more.



Body Material	Number of Drill Guides	Drill Guide Spacings	Clamping Method	Workpiece Thickness Settings
Glass-Filled Nylon	2	3/4" (19mm)	Works with a variety of common clamps. Clamp Pad Adapter accepts any Kreg Face Clamp.	1/2", 5/8", 3/4", 7/8", 1", 1 1/8", 1 1/4", 1 3/8", 1 1/2" (12m, 16mm, 19mm, 22mm, 25mm, 29mm, 31mm, 35mm, 38mm)

### FEATURES

#### A CLAMP PAD ADAPTER

The Kreg Jig® R3's clamp pad adapter allows the jig to be attached directly to any Kreg® Face Clamp for faster and more-repeatable pocket holes. In addition, the R3 can be secured to your workpiece with any standard bar clamp or C-clamp.

#### B MATERIAL THICKNESS SETTINGS

From thin drawer boxes and craft projects to stout 2x4s, this jig can handle just about anything. Independent positioning sliders feature nine depth settings, allowing you to easily join materials from 1/2" (12mm) to 1 1/2" (38mm) thick in 1/8" (3mm) increments.

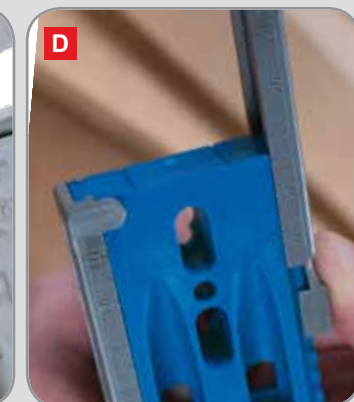
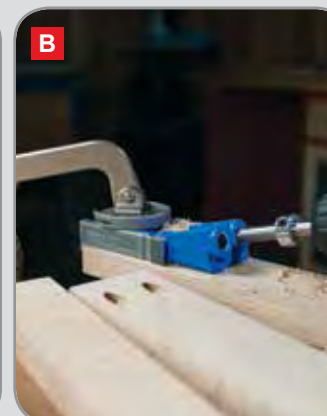
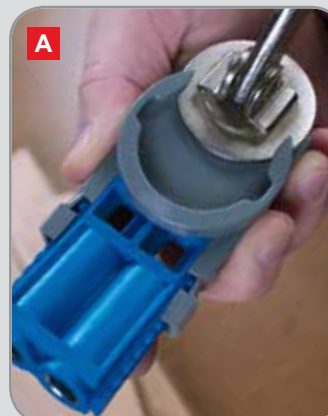

#### C ORGANIZED CARRYING CASE

The R3 comes in a durable carrying case to keep materials organized and to make sure that you always have the tools you need on hand. As a bonus, we've molded a depth setup gauge into the case for handy reference.

#### D EASY-PRESS™ POSITIONING SLIDERS

To properly set the jig, simply position the sliders on the side of the jig and move the sliders so that your material thickness is aligned with the arrow on the jig body to set your drilling depth.



# Kreg Jig® HD

ITEM# KJHD

## The Heavy-Duty Solution for Pocket-Hole Construction

Bigger bit, bigger screws, and of course—bigger projects. The Kreg Jig® HD delivers the strength and confidence you need to BUILD BIG!

Designed with the same tried-and-true efficient design and hardened-steel drill guides as the original Kreg Jig®, the Kreg Jig® HD lets you create joints in 1½" (38mm) and thicker materials that are an amazing 50% stronger than traditional Kreg Joints™.

### Includes:

HD Drill Guide, stop block, ½" (12mm)-diameter HD stepped drill bit, 6" (152mm) HD driver bit, stop collar, hex wrench, starter Kreg® Screw set, and owner's manual.

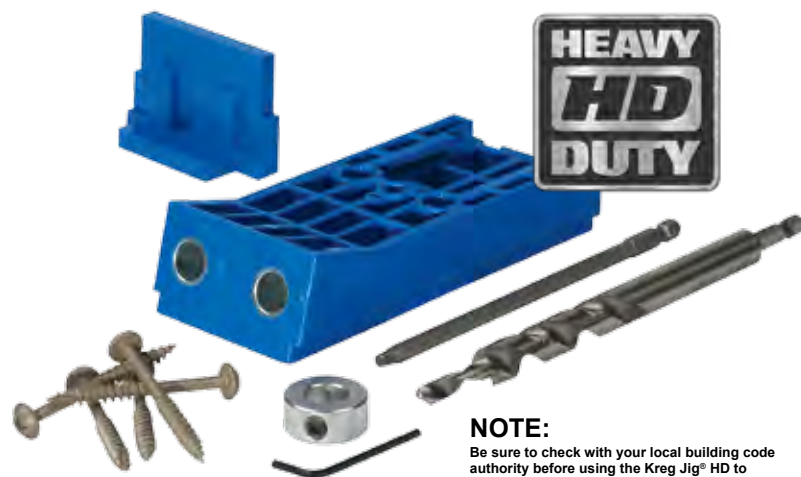

### NOTE:

Be sure to check with your local building code authority before using the Kreg Jig® HD to construct load bearing objects such as interior walls or deck railings. Building codes differ from area to area. Please refer to the applications in user manual or [www.kregtool.com](http://www.kregtool.com) for more information.



Body Material	Number of Drill Guides	Drill Guide Spacings	Workpiece Thickness Settings
Glass-Filled Nylon	2	1½" (36mm)	1½" (38mm)

**Heavy-Duty Screws:**  
The Kreg Jig® HD works with 2x4s and larger stock. It utilizes heavy-duty #14 hardened-steel screws that offer incredible shear-resistance and have three anti-corrosion layers for long-term corrosion resistance. See page 20 to learn more.



### It Works Wherever You Do:



Whether you're framing walls, building deck railings, backyard furniture, fences, benches, or any other large project, you always want the strongest joint possible. This is where the Kreg Jig® HD excels – strength.

# Kreg Jig® Mini

ITEM# MKJKIT

## Simplicity at its Finest

The Kreg Jig® Mini is a great entry point into Kreg Joinery™, and the perfect choice when the smallest jig possible is required. This compact design includes the hardened-steel guide of traditional Kreg Jigs® and allows you to drill pocket-holes in tight spots.

**Includes:**  
Kreg Jig® Mini, stepped drill bit, depth collar, and hex wrench.



**PLUG-SETTING FEATURE**  
The Mini's plug setting feature is fast, easy, and safe.



**UNLIMITED MATERIAL THICKNESS**  
The Kreg Jig® Mini has a fenceless design that allows you to make precise angle and stock-depth adjustments as needed.

### SPECIFICATIONS

Body Material	Number of Drill Guides	Clamping Method	Workpiece Thickness Settings
Glass-Filled Nylon	1	Works with a variety of common clamps or any Kreg Face Clamp.	½" (12mm), ¾" (12mm), 1½" (38mm)

## Choosing a Kreg Jig®

A Kreg Jig® makes it easy for anyone, from the beginning DIYer to the advanced woodworker to the professional carpenter, to create rock-solid wood projects and to make strong, long-lasting repairs. All you need to succeed is a Kreg Jig®, a drill, and a handful of Kreg® Screws.

With several models and types to choose from, though, you may need some help selecting the Kreg Jig® that's right for you. Take a look at the overview information below to help find the Kreg® solution that's right for you. Of course, you can learn much more about each Kreg Jig® and get full product details on the previous pages.

Foreman Item# DB210	Kreg Jig® K5 Item# K5	Kreg Jig® K4 Item# K4	Kreg Jig® R3 Item# R3	Kreg Jig® HD Item# KJHD	Kreg Jig® Mini Item# MKJKIT
SMALL-LARGE SCALE PROJECTS	SMALL-LARGE SCALE PROJECTS	SMALL-LARGE SCALE PROJECTS	SMALL SCALE PROJECTS	OUTDOOR PROJECTS SMALL-LARGE	SMALL SCALE PROJECTS
PROJECTS WITH 75+ POCKET HOLES	PROJECTS WITH 25-50 POCKET HOLES	PROJECTS WITH 25-50 POCKET HOLES	PROJECTS WITH 10-25 POCKET HOLES	PROJECTS WITH 1-100 POCKET HOLES	PROJECTS WITH 1-10 POCKET HOLES
MULTIPLE THICKNESS SETTINGS	MULTIPLE THICKNESS SETTINGS	MULTIPLE THICKNESS SETTINGS	MULTIPLE THICKNESS SETTINGS		
BUILT-IN CLAMPING	BUILT-IN CLAMPING				
FAST CLAMPING	FAST CLAMPING				
EXTRA STRENGTH FOR 2X4 MATERIAL *ACCESSORY REQUIRED				EXTRA STRENGTH FOR 2X4 MATERIAL AND LARGER	
STORAGE	STORAGE				
HIGH-SPEED POCKET HOLES					
LARGE WORK PIECE SUPPORT	LARGE WORK PIECE SUPPORT				
	GREAT FOR REPAIRS	GREAT FOR REPAIRS	GREAT FOR REPAIRS		GREAT FOR REPAIRS
UPGRADE TO MICRO/HD *ACCESSORY REQUIRED	UPGRADE TO MICRO/HD *ACCESSORY REQUIRED	UPGRADE TO MICRO/HD *ACCESSORY REQUIRED			



# Your KREG® projects demand KREG® Screws.

Kreg® screws are built with specialized features that work together to ensure the strongest joint possible. They also make driving easy and help to reduce wood splitting. Choosing Kreg® Screws will give you the best results possible. To get these great results, you need to choose the best Kreg screw for your particular project. Choosing the right screw is easy once you understand the features of each screw type and how these features will impact the success of your project.



### Kreg® Screw container features:

- Easy-to-read, color-coded labels
- Durable, impact-resistant material
- Transparent containers
- Reusable for storing other hardware
- Resealable, tight-fitting lids
- 100, 250, 500, and 1,200 count sizes
- Nesting ability for easy storage

### STAINLESS STEEL

Our stainless screws are specially designed for high-moisture applications, excessive exposure to water, and other exceedingly corrosive environments, such as ACQ-treated lumber.

Item#	Thread	Length	Head Style	Qty.	Diameter
SML-C125S5	Coarse	1¼" (32mm)	Maxi-Loc™	100	#8
SML-C150S5	Coarse	1½" (38mm)	Maxi-Loc™	100	#8
SML-C250S5	Coarse	2½" (64mm)	Maxi-Loc™	50, 250, 2000	#10
SML-F125S5	Fine	1¼" (32mm)	Maxi-Loc™	100	#7

### BLUE-KOTE FINISH

Blue-Kote™ screws are made from case-hardened steel, and feature three anti-corrosion layers, perfect for indoor and outdoor projects. They provide rust-resistance up to 400% greater than zinc-plated screws and work with pressure-treated material.

Item#	Thread	Length	Head Style	Qty.	Diameter
SML-C125B	Coarse	1¼" (32mm)	Maxi-Loc™	100, 1200	#8
SML-C150B	Coarse	1½" (38mm)	Maxi-Loc™	100, 1200	#8
SML-C2B	Coarse	2" (51mm)	Maxi-Loc™	50, 250	#8
SML-C250B	Coarse	2½" (64mm)	Maxi-Loc™	50, 125, 250, 2000	#8

### ZINC COATED

Our zinc-coated screws are made from case-hardened steel, and are recommended for a wide variety of indoor projects where exposure to moisture is not a significant concern.

Item#	Thread	Length	Head Style	Qty.	Diameter
SML-C1	Coarse	1" (25mm)	Maxi-Loc™	100, 500, 1200	#8
SPS-C1	Coarse	1" (25mm)	Pan Head	100, 250, 500, 1200	#6
SML-C125	Coarse	1¼" (32mm)	Maxi-Loc™	100, 250, 500, 1200, 5000	#8
SML-C150	Coarse	1½" (38mm)	Maxi-Loc™	100, 250, 500, 1200	#8
SML-C2	Coarse	2" (51mm)	Maxi-Loc™	50, 250, 3000	#8
SML-C250	Coarse	2½" (64mm)	Maxi-Loc™	50, 125, 250, 2000	#8
SPS-F075	Fine	¾" (19mm)	Pan Head	100, 500, 1200	#6
SPS-F1	Fine	1" (25mm)	Pan Head	100, 500, 1200	#6
SML-F125	Fine	1¼" (32mm)	Maxi-Loc™	100, 250, 500, 1200, 5000	#7
SPS-F125	Fine	1¼" (32mm)	Pan Head	100, 500, 1200	#6
SML-F150	Fine	1½" (38mm)	Maxi-Loc™	100, 500, 1200	#7
SPS-F150	Fine	1½" (38mm)	Pan Head	100, 500, 1200	#6

### HEAVY DUTY

### PROTEC-KOTE

Kreg HD Screws are designed for use with the Kreg Jig® HD and with 1½" and thicker stock. These 2½"-long, #14 hardened-steel screws provide incredible shear-resistance, and have a Protec-Kote™ finish with three anti-corrosion layers for long-term moisture resistance. Require a #3 square drive.

Part#	Thread	Length	Head Style	Qty.	Diameter
SML-C2X250	Coarse	2½" (64mm)	Maxi-Loc™	30, 125	#14

## Screw Organizer ITEM# KTC25

### A Compact, Convenient Case for Kreg® Screws and More

The Kreg® Screw Organizer offers a great way to store Kreg Screws in a compact, easy-to-carry, easy-to-store package. The Screw Organizer is also a perfect companion to the Kreg System Organizer, making it easy to create a coordinated, stackable organizing system for Kreg Screws and an entire Kreg Joinery™ System.

The Screw Organizer holds up to 14 new Kreg Screw containers. Tabs on the containers nest into recesses in the Screw Organizer, so they stay put when the Screw Organizer is standing upright or being carried. A transparent lid makes it easy to see what's stored inside, and the Screw Organizer even allows new Kreg Screw containers to be stored with the lids off—without spilling the screws—when the Screw Organizer is closed and carried.



### SPECIFICATIONS

- 18" wide x 15¼" tall x 2½" deep
- Impact-resistant
- Transparent lid
- Heavy-duty lid clasps
- Molded recesses to hold Kreg Screw containers (30, 50, 100, 125, and shallow 250-count sizes)
- Also holds Kreg Hardware Containers (Small and Large sizes)
- Screw containers and Hardware Containers stay in place when Organizer is carried

\*Optional Items Shown Not Included  
Holds all shallow-depth Kreg® Screw containers, plus Small and Large Kreg® Hardware Containers

## Hardware Containers

Hardware Containers are the perfect solution for storing and organizing all kinds of loose hardware. These handy containers are the same durable, resealable, reusable containers that are used to package Kreg Screws. Hardware Containers, though, have lids with a surface you can write on to easily identify what's inside. Available in Small and Large sizes, Hardware Containers fit inside the Screw Organizer (above), and in the System Organizer (page 23). Sold in packs of four.

### Sizes:

Small: 3" wide x 4¼" tall x 17/8" deep  
Large: 4¼" wide x 6¼" tall x 17/8" deep



Fill 'em

Label 'em

Stack 'em

Store 'em



### Screw Kit

This kit contains five of the most popular self-tapping screw sizes for Kreg Joinery™ in a durable, easy-to-carry case.



Included:	QTY.
SPS-F1	150
SPS-C1	150
SML-F125	150
SML-C125	150
SML-C250B	75

### Blue-Kote™ Screw Kit

This kit contains four of the most popular, weather-resistant screws in a durable, easy-to-carry case. Perfect for outdoor use.



Included:	QTY.
SML-C125B	100
SML-C150B	100
SML-C2B	100
SML-C250B	150

### BLUE-KOTE FINISH



## Screw Selector Wheel

ITEM# SSW

The Screw Selector Wheel makes it easier than ever to build projects with Kreg Joinery™. Just dial in the thickness of each piece to be joined—whether those thicknesses are the same or different—and the Wheel shows you the correct screw length and Kreg Jig® setting.

### Features

- Two-sided: shows face joints and edge joints
- Works with ½", ⅝", ¾", ⅞", 1", 1⅛", 1¼", 1⅜", 1½" (12mm, 16mm, 19mm, 22mm, 25mm, 28mm, 31mm, 35mm, 38mm) material
- Compatible with Kreg Jig® K3, K4, K4MS, K5, and R3
- Durable .5mm polypropylene construction
- Tab with hole makes wheel easy to hang



## System Organizer

ITEM# KTC55

Store and Organize Your Entire Kreg Joinery™ System In One Compact, Convenient Case

The all-new System Organizer is the perfect place to store and organize all of your Kreg Joinery™ system parts—your Kreg Jig®, Kreg® Clamps, Kreg® Screws, drill and driver bits, and more. A portion of the Organizer's tray can be removed for storage of other items such as the Kreg® Shelf Pin Jig, compact drills and drivers, and more.

It's easy to keep track of everything stored in the System Organizer thanks to a transparent lid. A pair of heavy-duty clasps ensure that lid stays shut, and a large handle makes the Organizer easy to carry so you can take your Kreg® tools on the go.



### The Storage Solution for Kreg Jigs® and Accessories



**Durable construction**  
with impact-resistance



**Removeable molded insert**  
keeps all accessories close at hand



**Transparent lid**  
for easy visual inventory

### Features:

- Durable polycarbonate/polypropylene construction
- Generous 18" x 15¼" x 6⅝" size
- Custom-fitted inserts for Jigs & Accessories
- Transparent lid for easy visual inventory
- Removable section for storage versatility

### Joining Solutions / Kreg® Plugs

## Pocket-Hole Plugs

For those times when pocket holes won't be hidden on the backside of your project or you want to highlight them decoratively, use Kreg® Pocket-Hole Plugs. Plugs are offered in seven solid wood species, and five plastic plug colors for use on laminated surfaces.

### Wood Plugs

Available in Quantities of:

#P-MAP		Maple	50
#P-WAL		Walnut	50
#P-OAK		Oak	50
#P-PIN		Pine	50
#P-CHE		Cherry	50
#P-CDR		Cedar	50
#P-PNT		Paint Grade	50

### Plastic plugs

Plastic Plugs are great for laminated surfaces and come in five colors.

Available in quantities of:

#CAP-BRN		Brown	50
#CAP-BLK		Black	50
#CAP-WHT		White	50
#CAP-ALM		Almond	50
#CAP-LTB		Light Brown	50

### Wood Micro-Pocket™ Plugs

High-quality solid-wood plugs for your Micro-Pocket™ pocket holes.

Available in quantities of:

#P-MICRO-MAP		Maple	65
#P-MICRO-OAK		Oak	65
#P-MICRO-PIN		Pine	65
#P-MICRO-CHE		Cherry	65
#P-MICRO-PNT		Paint-Grade	65

## Micro-Pocket™ Drill Guide

Create Compact Pocket Holes

With a 25% smaller hole diameter, the Micro-Pocket™ Drill Guide lets you create compact pocket holes in almost all Kreg Joinery™ applications. You also have the ability to tackle smaller projects, thinner stock, and tighter repair applications, where standard pocket holes simply can't go. Designed for use with the Kreg Jig® K3, K4, and K5.

### Includes:

Micro-Pocket™ Drill Guide, Kreg® Micro drill bit, stop collar, hex wrench, and sample pocket-hole screws.

ITEM# KJMICRODGB



### SPECIFICATIONS

Body Material	Number of Drill Guides	Drill Guide Spacings	Workpiece Thickness Settings
Glass-Filled Nylon	3	9/16", 7/8", 1 1/16" (14mm, 32mm, 36mm)	1/2", 5/8", 3/4", 7/8", 1", 1 1/8", 1 1/4", 1 1/2", 1 3/4" (12mm, 16mm, 19mm, 22mm, 25mm, 28mm, 31mm, 35mm, 38mm)

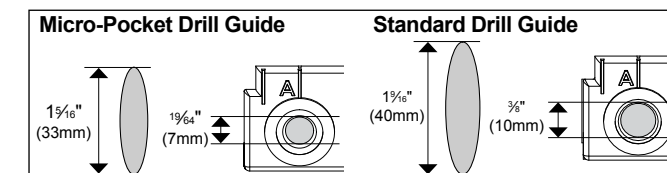

Endless Applications



Perfect for ½" (12mm) Stock



Perfect for Narrow Stock



Compatible with the Kreg Jig® K3, K4, and K5



# Kreg Jig® Accessories

## Kreg Jig® Portable Base

Accepts your Kreg Jig® Drill Guide Block and connects to most Kreg® Face Clamps for portable pocket holes. Allows your jig to be used as two tools in one: a sturdy benchtop jig and a portable jig for work on the go.



ITEM# KPDGB



## Dust Collection Attachment

This handy attachment connects any standard 1 1/4" (32mm) vacuum hose to your Kreg Jig® for faster drill strokes and a cleaner shop. Only for use with the Kreg Jig® K3, K4, and Kreg Jig® K4 Master System.



ITEM# KJDCA



## Drill Bits

Kreg® drill bits feature a one-piece design that eliminates clogging and provides a much smoother, faster drilling stroke than the drill bits with replaceable center drills. The KJD Bit for our manual Kreg Jigs® is made of high-speed steel, while the DKDB machine bit is made of cobalt-steel to increase bit life. Because the DKDB bit is 3/8" (10mm) in diameter, it can be used in any manual Kreg Jig® as a premium replacement. Be sure to order the left-handed drill bit (LH-DKDB) for the center spindle of the DK3100 fully-automatic machine.

- #DKDB For DK1100, DK3100, and DK5100
- #LH-DKDB For DK3100 Center Spindle (Left Hand)
- #KJD For Kreg Jigs®
- #KJDHD For Kreg Jig® HD (not shown above)
- #KJSC/D Depth Collar / Hex Wrench (not shown above)
- #KJD/MICROBIT For Micro-Pocket Drill Guide
- #KJSC/MICROBIT Micro-Pocket Depth Collar / Hex Wrench (KJSC/MICROBIT not shown above)

## Material Support Stop

This handy Kreg Jig® accessory can be positioned any distance from your Kreg Jig® to repeat the same pocket holes. Can also be swung out of the way to serve as a support for large panels.



ITEM# KJSS



## Drill Guide Spacer Blocks

Drill Guide Spacer Blocks make it quick and easy to compensate for additional material thickness in 1/4" (6mm) increments. Works with the Kreg Jig® K3, K4, K4MS, K5 and K5MS. Set of 3.



ITEM# KDGADAPT



## Hex Shank Drill Bit

ITEM# QUIK-BIT

Designed specifically for Kreg Joinery™. Standard 1/4" (6mm) Hex Shank works with any standard quick-change chuck.

## Quick-Change Kit

ITEM# QUIK-KIT

This simple kit provides everything you need to switch from drilling pocket holes to driving pocket screws in just seconds.

### Includes:

- Quick-Change chuck
- #2 square driver
- Hex shank pocket-hole bit
- Depth collar / hex wrench



## Drivers

Kreg square-drive bits have deep tips that greatly reduce cam-out when driving screws. #2 drivers (for all except HD screws) come in 3" (76mm) and 6" (152mm) lengths. The 6" length is easiest to use in most applications, while the 3" is perfect for working in tight spots. The #3 HD (Heavy Duty) driver comes in 6" length.

- #DDS 3" (76mm) & 6" (152mm), #2 Square Driver Set
- #D6X2 (2) - 6" (152mm), #2 Square Driver Set
- #D6HD 6" (152mm), #3 Square Driver for Kreg Jig® HD

# Deck Jig™

ITEM# KJDECKSYS

## The Ultimate Concealed Decking System

With the Kreg® Deck Jig™ and a few simple tools you already own, you can create a beautiful, functional deck surface that is completely free of exposed fasteners and painful splinters. Concealed-decking systems utilize awkward steel fasteners or thin plastic clips to hold your deck boards in place. The Kreg® Deck Jig™ utilizes a more straightforward approach, creating an incredibly strong wood-to-wood bond through precisely-placed self-tapping screws.



### Includes:

Deck Jig™, instructional DVD, 100 Protec-Kote™ deck screws, 6" (152mm) Deck Jig™ drill bit, 6" (152mm) KTX square driver bit, (3) 3/8" (8mm) Deck Jig™ spacer rings, (3) 1/4" (6mm) Deck Jig spacer rings, (2) stop collars, (1) hex wrench, and a durable carrying case.



### FUNCTIONAL

An oversized, ergonomic, easy-grip handle gives you a secure hold and complete control over each and every hole you drill.



### DRILL.

#### Precise Angle

Drill holes into each edge of your deck board using the specialized stepped bit and the Deck Jig™ hardened-steel drill guides.

### PRECISE

Three hardened-steel Kreg® drill guides keep the specialized stepped drill bit and driver bit at the precise, optimal angle.



### DRIVE.

#### Accurate Screw Depth Every Time

Drive screws through the same drill guide and into the joist. The depth collar precisely controls drive depth.

### ACCURATE

Six handy spacer rings – three 1/4" (6mm) and three 3/8" (8mm) – ensure accurate deck board spacing for proper drainage and a longer deck life.



### DONE!

That's it! You've just created an incredibly strong and sturdy joint with no visible fasteners.

## RECOMMENDED ACCESSORIES



ITEM# KJD/DECKBIT and DECKDRIVER

**Deck Jig™ Drill Bit / Driver Bit**  
The Deck Jig™ drill bit and driver bit both feature hardened-steel construction and Quick-Change compatible hex shanks. Both bits are designed to work exclusively with the Kreg Deck Jig™ and come complete with a depth collar and hex wrench to help control your plunge depth.



ITEM# DECKSPACER-BLUE and DECKSPACER-RED

**Deck Jig™ Spacer Rings**  
Ensure a consistent spacing – 3/8" (8mm) or 1/4" (6mm) – between your deck boards while you drive your screws to secure the board. Rings feature a large handle for quick placement. Works with the Kreg Deck Jig™. Available in two sizes: 3/8" (8mm) (blue) or 1/4" (6mm) (red). Set of 12.



ITEM# KJHD

**Kreg Jig® HD**  
If you build a lot of outdoor projects and work with 2x4's and larger stock, this is the Kreg Jig® for you. The Kreg Jig® HD has a bigger bit and utilizes bigger #14 screws, so that you can build bigger and stronger projects. See page 18.



## Deck Screws



### Stainless 2" (50mm) Deck Screws

To provide the ultimate protection, choose stainless. Stainless screws provide the best protection against corrosion in the long-term. Available in 100-count and 700-count packages.

**100 ct.**

ITEM# SDK-C2SS-100

**700 ct.**

ITEM# SDK-C2SS-700  
(Driver Bit included)



### Protoc-Kote™ 2" (50mm) Deck Screws

These 2"-long Protoc-Kote™ deck screws are designed for use with 4/4 and 5/4 decking material, and work with the Kreg Deck Jig™. Protoc-Kote™ features three anti-corrosion layers that are chemically combined to provide strong protection against rust and corrosion in many common outdoor applications. Perfect for ACQ-treated lumber. Available in 100-count and 700-count packages.

**100 ct.**

ITEM# SDK-C2W-100

**700 ct.**

ITEM# SDK-C2W-700  
(Driver Bit included)



### Protoc-Kote™ 2 5/8" (67mm) Deck Screws

These deck screws are designed for use with the Kreg Deck Jig™ and 2x decking, or as a general fastener for a wide variety of deck projects. Protoc-Kote™ features three anti-corrosion layers chemically combined to provide strong protection against rust and corrosion in many common outdoor applications. Perfect for ACQ-treated lumber. Available in 100-count and 525-count packages.

**100 ct.**

ITEM# SDK-C262W-100

**525 ct.**

ITEM# SDK-C262W-525  
(Driver Bit included)

### How many screws will you need?

# of Screws	Size of Deck
700 Screws	10' x 20' Deck (3mx6m)
1,400 Screws	20' x 20' Deck (6mx6m)
2,100 Screws	20' x 30' Deck (6mx9m)

\*Based on 16" joist spacing.

## Standard DECK vs. Kreg DECK

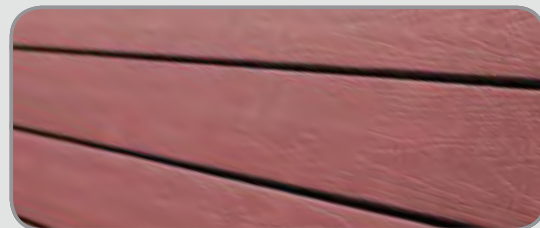
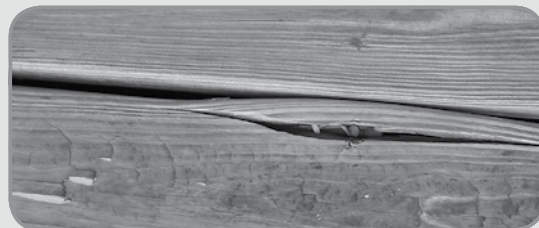
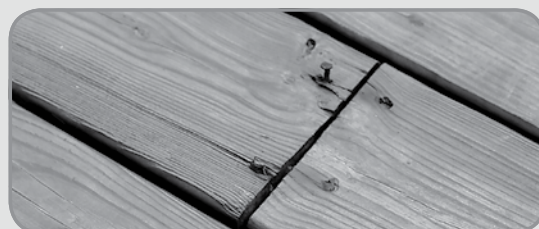
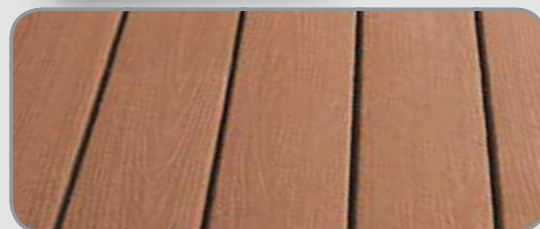
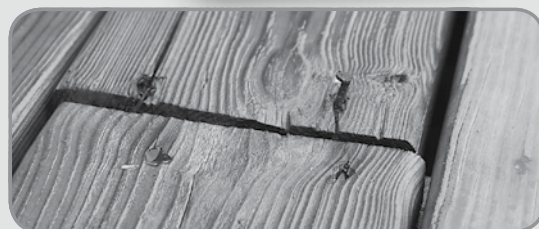

### THE Kreg Deck Advantage

#### Looks Better

Get the deck you want, without unsightly exposed fasteners. Kreg® Deck Screws are driven at an angle into the edge of your deck boards so they stay hidden from view.

#### Lasts Longer

Seasonal changes can force traditional fasteners out of place with time. Kreg® Deck Screw heads stay safely below the surface, for a longer-lasting deck.

#### More Comfortable

Bare feet? Don't worry. By coupling the Kreg Deck Jig™ with composite decking, you'll get a deck free of cracks, splinters, and "pop-out" fasteners.



## DK1100 Series Single-Spindle Machines

Fast. Quiet. Reliable.

The DK1100 Pro Series machines set the standard in the industry for drilling a single pocket hole at a time. We've packed these machines with functional features that set them apart from the competition. Choose from electric- or pneumatic-powered, freestanding- or bench-mounted to fit the way you build. Each DK1100 machine is built with an industrial-grade motor that provides the power to run day after day – quickly, quietly, and reliably – in even the most high-production environments.

### It Works For You

The DK1100 series of machines are the standard in the industry for drilling one pocket hole at a time. We've packed features into these machines that really set them apart from the competition. Choose from electric or pneumatic power, free-standing or bench-mounted to fit the way you build.



The DK1100 is available in three models – 1 Electric and 2 Pneumatic – that fit the needs of almost any production shop.

### DK1100 FE

Add real productivity and efficiency to your shop with the "Production Pocket-Hole Standard." This model works with any standard 20-AMP, 110-volt outlet and features a strong 1½-HP electric motor, single-spindle simplicity, and a cycle time of less than one second.



ITEM# DK1100 FE

### DK1100 FP

Already set up for pneumatic? This model features an industrial-grade 1½-HP pneumatic motor that is capable of the same pocket-hole productivity as the electric version. Requires a compressor able to produce 8 CFM at 120 PSI (50% duty cycle).



ITEM# DK1100 FP

### DK1100 TP

This model is identical to the DK1100 FP, but comes in a much smaller frame. It features a table height of 8" (203mm), making it easy to build into your workbench or relocate from time to time. Requires a compressor able to produce 8 CFM at 120 PSI (50% duty cycle).



ITEM# DK1100 TP

Motor	Drill Bits	CFM Rating	Cycle Time	Material Clamping Capacity	Hole Centering Capacity	Weight	Dimensions	Warranty
Electric Model: 1½-HP, 110-Volt, Single-Phase  Pneumatic Models: 1½-HP	DKDB Drill Bit (3/8" (10mm) Shank Dia., 3/16" (5mm) Pilot, 1/2" (13mm)-long)	TP & FP: 8-CFM at 50% Duty Cycle (120 PSI/min) FE: 1 CFM clamp cylinder (90 PSI/min)	1 second	4" (102mm)	1/2" (13mm) material to 1 1/2" (38mm) material	TP: 77 lbs. (35kg), FP: 138 lbs. (63kg), FE: 176 lbs. (80kg)	TP: 19"H x 24"W x 24"D (500mm)H x (610mm)W x (610mm)D (8" (203mm) table height) FP: 50"H x 24"W x 24"D (1000mm)H x (610mm)W x (610mm)D (40" (1000mm) table height) FE: 50"H x 24"W x 24"D (1000mm)H x (610mm)W x (610mm)D (40" (1000mm) table height)	5 Year Limited Warranty

#### A CONVENIENT SWING STOPS

Quickly position pocket holes across rails of various widths by placing them against one stop, drilling the pocket hole, and then repeating with the rail against the other stop. When you want to drill pocket holes in panels, the stops swing out of the way.

#### B ADJUSTABLE FENCE

Adjustments couldn't be easier as the fence adjusts right from the top of the machine to let you center a pocket hole in 1/2" (13mm) to 1 1/2" (38mm) thick materials. The hold-down clamp also adjusts to allow materials up to 4" (102mm) thick to be drilled.



#### C QUICK DRILL BIT CHANGES

Changing drill bit is a quick, simple process. Simply loosen the collet with the included hex wrench, replace with a new bit, and you are back in production in less than 60 seconds!

#### D MOTORS BUILT TO LAST

The industrial-grade motors in Kreg® pocket-hole machines are built for long-lasting service. Kreg® machines are also designed to minimize stress on moving parts, greatly reducing the likelihood of failure.





## DK5100 Panel-Boring Machine

ITEM# DK5100

### One Machine Cycle. Five Pocket Holes.

Five industrial-grade motors, five individually-activated clamping cylinders, and five durable drill spindles; all in one amazing machine. The DK5100 makes drilling multiple pocket holes across cabinet sides, shelving, stairs, and window or door extensions easier than ever before. It can beat the bottleneck that's slowing down your shop and significantly improve your bottom line.

This machine is built for the shop that has a specific repetitive application that demands increased productivity. The time saved by drilling up to five pocket holes at once is truly dramatic and will allow you to reallocate resources to areas of your shop that need more attention.



Don't let bit changes slow you down. The simple and straightforward design of the DK5100 – and all of our machines – lets you make easy bit changes in 60 seconds or less.

#### Increase Your Shop Output

This machine is built for the shop that has repetitive applications that demand increased productivity. The time saved by drilling up to five pocket holes at once is truly dramatic and allows you to reallocate resources to areas of your shop that need more attention.

Motor	Drill Bits	CFM Rating	Cycle Time	Material Clamping Capacity	Hole Centering Capacity	Weight	Dimensions	Warranty
(5) pneumatic, 3/4-HP motors and 6" (152mm) on-center spindle spacings	(5) DKDB Drill Bits (3/8" (10mm) Shank Dia., 3/16" (5mm) Pilot, 1/2" (12mm)-long)	20 CFM at 50% Duty Cycle (120 PSI)	2 seconds	1 3/4" (44mm)	1/2" (12mm) material to 3/4" (19mm) material	350 lbs. (160kg)	50"H x 36"W x 24"D (1200mm)H x (900mm)W x (610mm)D (40" (1000mm) table height)	5 Year Limited Warranty

#### INDIVIDUAL CONTROL

Each of the five spindles is controlled with an on/off switch located on each clamping tower, giving you instant control of every spindle. Drill with all five spindles at once or turn a couple off to meet the needs of your project.



#### 5 POCKET HOLES, 1 CYCLE

The DK5100's five spindles are spaced 6" (152mm) on-center, the perfect spacing for many panel applications. A simple tap of the foot pedal creates five uniform pocket holes in less than two seconds. Now that's productivity.



#### PNEUMATIC POWER

All five drill spindles are driven by industrial-grade pneumatic motors that are designed to provide you with plenty of drilling power, panel after panel, year after year.



#### RECOMMENDED ACCESSORIES



**DKDB Drill Bit**  
3/8" (10mm) drill bit. Highly heat-resistant, cobalt-steel construction for prolonged bit life.

ITEM# DKDB



**Self-Tapping Pocket-Hole Screws**  
Square drive, case-hardened, flat head, self-tapping screws. Perfect for any pocket-hole application. (See page 20)

## DK3100 Series Multi-Spindle

ITEM# DK3100

### Build Quality Face Frames, Twice as Fast!

If you're looking for the ultimate machine to build face frames, this is it. The multi-spindle DK3100 contains three spindles that allow you to drill two pocket holes across rails of varying widths in just one machine cycle. Best of all, the DK3100 can be quickly changed to drill a single pocket hole, by simply removing a drill bit. If you're serious about face-frame production, the DK3100 is the machine that will deliver real performance to your shop and profits to your bottom line.

The DK3100 drills two pocket holes in one cycle. Plus, it gives you options for spacing the holes. You can set the drill spindles at 3/4" (19mm), 1" (25mm), and 1 1/4" (44mm) on center, perfect for today's most-common rail widths.

#### Pocket Holes Twice as Fast!

Multiple spindles give you the option of three hole spacings to fit today's most common face-frame widths. If you prefer to drill only one pocket hole, no problem! Just remove a drill bit and you get the equivalent of our DK1100 single-spindle machine. Only Kreg® offers you the option of one or two pocket holes at a time and your choice of three on-center hole spacings *IN THE SAME MACHINE!*

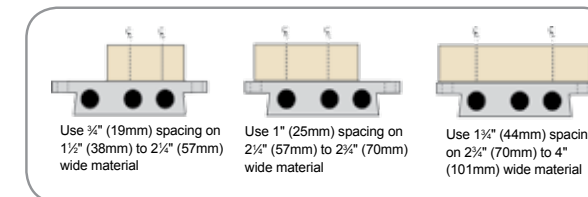

The DK3100 not only drills two pocket holes in one cycle, it also gives you options for spacing the holes. You can set the drill spindles at 3/4" (19mm), 1" (25mm) and 1 1/4" (44mm) on center, perfect for today's most common rail widths.

**On-Center Spindle-Spacings:** 3/4" (19mm), 1" (25mm), 1 1/4" (38mm)



Motor	Drill Bits	CFM Rating	Cycle Time	Material Clamping Capacity	Hole Centering Capacity	Weight	Dimensions	Warranty
Electric, 1 1/2-HP, 110-Volt, Single Phase	LH-DKDB and (1) DKDB Drill Bits (3/8" (10mm) Shank Dia., 3/16" (5mm) Pilot, 1/2" (12mm)-long)	1 CFM clamp cylinder (90 PSI)	1 second	4"	1/2" (12mm) material to 1 1/2" (38mm) material	176 lbs. (80kg)	50"H x 24"W x 24"D (1270mm)H x (610mm)W x (610mm)D (40" (1000mm) table height)	5 Year Limited Warranty

#### EASY SETUP

The lift-off top gives you direct access to the drill bits. A simple turn of a hex wrench in the drill bit collets is all it takes to change bits. In less than a minute, you can change to any of the three bits or set up the DK3100 for single-spindle drilling.



#### ONE SECOND CYCLE TIMES

Two pocket holes in one second? It's not a dream... It's reality with the DK3100. The one-touch foot pedal activates the spindle to make two perfect pocket holes in one second.



#### HIGHLY DURABLE

The DK3100 uses a hardened-steel drill guide that supports the drill bits all the way into the workpiece, prolonging drill bit life and improving the cut quality of the pocket hole. Drill guide carries a lifetime warranty.



#### RECOMMENDED ACCESSORIES



**DKDB Drill Bit**  
3/8" (10mm) drill bit. Highly heat-resistant, cobalt-steel construction for prolonged bit life.

ITEM# DKDB



**LH-DKDB Drill Bit (DK3100 only)**  
Left-handed 3/8" (10mm) drill bit. Highly heat-resistant, cobalt-steel construction for prolonged bit life.

ITEM# LH-DKDB



## Face-Framing Table ITEM# KFT4X8

### Face-Frame Assembly Made Easy

Fast face-frame assembly is great. Fast and accurate assembly that virtually eliminates sanding is even better. The Face-Framing Table has four clamping cylinders that can be precisely adjusted, applying perfect pressure to the joint line on almost any size of frame. The table stands at a 30-degree angle to the user, so it uses less floor space than a flat table. It also prevents back pain by allowing you to stand upright, rather than bent over.



**Flush Face Frames Made Easy:** 1) Align stile and rail along squaring fence 2) Adjust clamp cylinder and secure joint line 3) Drive self-tapping screw

Table Dimensions	Angle	Weight	Retractable Squaring Fence	Work Surface	Clamping	Accessories
76"H x 110"W x 30"D (1900mm)H x (2800mm)W x (7600mm)D	30° from vertical	350 lbs. (160kg)	Retracts out of the way for frames longer than 8' (2.4m)	4' (1.2m) x 8' (2.4m) melamine, 1/4" (28mm)-thick	Four high-quality clamping cylinders can be independently controlled. Activate one at a time or all at once with a master switch.	Add our Pneumatic Screw Gun and 8' (2.4m) Coil Hose

#### RETRACTABLE SQUARING FENCE

The aluminum squaring fence on the left side of the table retracts out of the way to accommodate frames longer than 8' (2.4m). Just begin your frame with the squaring fence up, then retract the fence as needed.

#### CUSTOMIZED SETUP

Each clamping cylinder can be independently controlled, so you can actuate each cylinder individually or activate them all at once with a master switch located at the bottom of the clamping arm.

#### POWERFUL CLAMPING

The four high-quality clamping cylinders apply tremendous pressure on the joint line to maintain a flush assembly. The clamping arm rolls easily on roller bearings and each cylinder glides smoothly along the arm for perfect positioning.



#### Perfectly Square. Perfectly Flush.

Fast assembly is great. Fast, accurate assembly that virtually eliminates sanding is even better. With the Framing Table, you'll get it all. It begins with the squaring fence for a perfectly square start. The pneumatic clamping cylinders hold your frame flush against the sturdy surface, helping to eliminate imperfections in the assembly so you'll rarely — if ever — need to finish-sand your frame.

#### RECOMMENDED ACCESSORIES



ITEM# CT6066

#### Pneumatic Screw Gun & 8' (2.4m) Polyurethane Coil Hose

This heavy-duty industrial pneumatic screw gun is perfect for use with our 4' (1.2m) x 8' (2.4m) Face Framing Table. It features a variable speed, pneumatic motor that provides up to 1,800-RPM at an average of 16-CFM, and durable construction for even the most high-production environments.

## A Kreg® Pocket-Hole Machine for Every Need

Fast, quiet, and built to perform in demanding production environments, Kreg® pocket-hole machines can drill 1, 2, 3, 4, or 5 pocket holes in just one machine cycle! The Face-Framing Table adds even more productivity in assembly, allowing quick, accurate, and convenient assembly of face frames.

With multiple options to choose from, it's easy to choose the right Kreg pocket-hole machine for your needs.

<b>DK1100 Series</b> These single-spindle pocket-hole machines are available in three styles to suit your shop and space needs. <b>DK1100 FE</b> <ul style="list-style-type: none"> <li>Floor-standing steel cabinet</li> <li>110-v, 11/2-HP single-phase motor</li> <li>Pneumatic clamp cylinder</li> </ul> <b>DK1100 FP</b> <ul style="list-style-type: none"> <li>Floor-standing steel cabinet</li> <li>Pneumatic 11/4-HP motor</li> <li>Pneumatic clamp cylinder</li> </ul> <b>DK1100 TP</b> <ul style="list-style-type: none"> <li>Tabletop steel cabinet</li> <li>Pneumatic 11/4-HP motor</li> <li>Pneumatic clamp cylinder</li> </ul>	<b>DK3100</b> This multi-spindle pocket-hole machine drills two pocket holes in one cycle, and offers three hole-spacing options. <ul style="list-style-type: none"> <li>Floor-standing steel cabinet</li> <li>110-v, 11/2-HP single-phase motor</li> <li>Pneumatic clamp cylinder</li> </ul> See page 30 to learn more	<b>DK5100</b> This multi-spindle panel-boring machine drills up to five pocket holes in one cycle with individually-controllable pneumatic drill motors and clamp cylinders. <ul style="list-style-type: none"> <li>Floor-standing steel cabinet</li> <li>Five 3/4-HP pneumatic motors</li> <li>Five pneumatic clamp cylinders on 6" spacing</li> </ul> See page 29 to learn more	<b>Face Framing Table</b> This assembly station makes face-frame assembly easy by placing the work at operator height, offering powerful, adjustable pneumatic clamping. <ul style="list-style-type: none"> <li>48" x 96" work surface at a 30° working angle</li> <li>Four pneumatic clamp cylinders</li> <li>Optional pneumatic screw gun</li> </ul> See page 31 to learn more

**Fast**  
Cycle times of 2 seconds or less... and we have machines that drill up to 5 holes per cycle! Fast, efficient and built for high-speed production.

**Durable**  
Unlike other drilling machines, Kreg machines use a hardened steel drill guide that supports the drill bit all the way into the workpiece, prolonging drill bit life and improving the cut quality of each pocket hole.

**Efficient**

The Kreg Pocket is almost a full inch shorter than a routed slot, making it easier to conceal.

**Quiet**  
No need to bring your earplugs... Kreg machines (electric and pneumatic) are the quietest on the market. Now that's something everyone in the shop can appreciate.

**Reliable**  
All Kreg Pocket-Hole Machines are TRUE production machines featuring high-quality industrial motors that are built to run all day, every day, in high volume production environments. Our unique design minimizes the stress on moving parts and eliminates failure-prone parts.

The Kreg Pocket features a flat shoulder that seats the screw properly for a strong hold.

**Repeatable**  
Kreg machines feature unique Swing Stops that allow your stock to be positioned in a repeatable fashion and pocket holes to be easily duplicated in the same location across cabinet rails. A Swing Stop can be quickly moved out of the way — and bypassed completely — by simply pushing your stock into its face.

**Quick**  
Don't let bit changes slow you down! All of our machines feature a simple and straightforward design which lets you switch bits in 60 seconds or less. After all, time IS money.

The Kreg Pocket features a 15° angle that makes it easier to drive than a 6° angle.

**Adjustable**  
Whether you're working with 1/2" material or 2x4s, we've got the machine to handle it. All Kreg Pocket-Hole Machines are easy to adjust for specific stock in just a few seconds.



# CLAMPING SOLUTIONS

Wood Project Clamps and Bench Clamps	33
Bench Clamps Systems	34
Clamp Vise and Right Angle Clamp	35
Classic Face Clamps and Corner Clamp	36
Auto-Adjust Bar Clamps	37
Clamp Tables and Components	38-39



## AUTOMAXX<sup>®</sup>

AUTO-ADJUST TECHNOLOGY

Automaxx<sup>®</sup> Technology makes clamping fast and foolproof by adjusting the clamp automatically to match the material thickness. Whether it's thick, thin, or in between, Automaxx<sup>®</sup> holds every time with the clamping pressure you set.



## Wood Project Clamps with Automaxx<sup>®</sup>

Wood Project Clamps are perfect for Kreg Joinery<sup>™</sup>, project assembly, general clamping, and more. Available in two sizes—3" (76mm) -reach and 6" (152mm) -reach—these versatile clamps have large clamp faces that distribute clamping force evenly and won't mar delicate surfaces. They are compatible with the Kreg Jig<sup>®</sup> R3's Clamp Pad Adapter, and with the Kreg Jig<sup>®</sup> Portable Base.

Thanks to Automaxx<sup>®</sup> Auto-Adjust Technology, Wood Project Clamps adjust to match material thickness automatically with a simple squeeze of the handles—whether the material is thick, thin, or in between. These clamps also feature easy-to-regulate clamping pressure with a simple thumbscrew.



### Wood Project Clamp 3" (76mm) Reach

3" (76mm) reach, 3" (76mm) capacity. This easy-to-use, compact clamp fits easily into tight spaces.



ITEM #KHC3

### Wood Project Clamp 6" (152mm) Reach

6" (152mm) reach, 5" (127mm) capacity. Offers increased reach and clamping capacity.



ITEM #KHC6

## Bench Clamps with Automaxx<sup>®</sup>

### Quick, Easy Benchtop Clamping with Automatic Adjustment

Bench Clamps offer the perfect solution for benchtop clamping. These versatile clamps are perfect for creating flush-fitting assemblies with Kreg Joinery<sup>™</sup>, and they're great for project assembly, routing, cutting, sanding, drilling, and more. Bench Clamps work with Clamp Trak and Plates, the Clamp Table, Mobile Project Center, and more to secure workpieces using an extra-large padded clamp face that evenly distributes clamping force.

Thanks to Automaxx<sup>®</sup> Auto-Adjust Technology, Bench Clamps adjust to match material thickness automatically with a simple squeeze of the handles—whether the material is thick, thin, or in between. These clamps also feature easy-to-regulate clamping pressure with a simple thumbscrew.



### Bench Clamp – 3" (76mm) Reach

3" (76mm) reach, 3/4" (83mm) capacity.



ITEM #KBC3

### Bench Clamp – 6" (152mm) Reach

6" (152mm) reach, 5" (127mm) capacity.



ITEM #KBC6



## Bench Clamp System

with **Automaxx**<sup>®</sup> ITEM #KBC3-SYS

### Create a 360° Benchtop Clamping Station

The Bench Clamp System combines a versatile 3" Bench Clamp with an anodized-aluminum Clamp Plate to create a 360° clamping station that can be recessed into just about any wood surface, such as a workbench, sawhorse, or work table. The plate gets recessed into the surface. That way, the clamp can be removed—by sliding it out of the keyhole slot in the plate—and the plate won't interfere with a flat work surface.

Thanks to Automaxx<sup>®</sup> Auto-Adjust Technology, the Bench Clamp adjusts to match material thickness automatically with a simple squeeze of the handles—whether the material is thick, thin, or in between. The clamp allows easy regulation of clamping pressure with a simple thumbscrew.



### Bench Clamp System

Includes Bench Clamp with 3" (76mm) reach, 3/4" (83mm) capacity, aluminum Clamp Plate, mounting hardware.



## Heavy-Duty Bench Clamp System

with **Automaxx**<sup>®</sup> ITEM #KBC3-HDSYS

### Portable Clamping Station for Wood Projects

For 360° clamping on the go, check out the Heavy-Duty Bench Clamp System. It combines a 3" (76mm) Bench Clamp with a thick 10" (254mm) x 10" (254mm) powder-coated steel plate. Rubber feet allow this system to be used anywhere. Or, the plate can be recessed into a work surface.

Thanks to Automaxx<sup>®</sup> Auto-Adjust Technology, the Bench Clamp adjusts to match material thickness automatically with a simple squeeze of the handles—whether the material is thick, thin, or in between. The clamp allows easy regulation of clamping pressure with a simple thumbscrew.

### Heavy-Duty Bench Clamp™ System

Includes Bench Clamp with 3" (76mm) reach, 3/4" (83mm) capacity, a large 1/4" x 10" x 10" (6mm x 254mm x 254mm) powder-coated steel plate, rubber feet



## Clamp Vise

with **Automaxx**<sup>®</sup> ITEM# KBC3-VISE

### Multipurpose Vise System for Wood Projects

The Clamp Vise combines a 3" (76mm) Bench Clamp with an anodized aluminum plate that mounts to the edge of a benchtop to create a simple, highly effective bench vise. It's great for clamping pieces on edge, supported by adjustable Clamp Blocks, and for holding large pieces on top of a bench like a traditional end vise using a pair of included Kreg Bench Dogs.

Thanks to Automaxx<sup>®</sup> Auto-Adjust Technology, the Bench Clamp adjusts to match the material automatically with a simple squeeze of the handles—whether the material is thick, thin, or in between. The clamp allows easy regulation of clamping pressure with a simple thumbscrew.

#### Includes:

Automaxx<sup>®</sup> Bench Clamp™, Clamp Vise™ Plate, 2 Clamp Blocks™, 2 Bench Dogs, 2 Bench Brakes, installation hardware and instructions.



Mounts to almost any surface 1" to 2" (25mm-50mm) thick



Allows horizontal, vertical and vise-style clamping



Holds workpieces securely in place while you work



Clamp Blocks support and align workpieces

## Right Angle Clamp

with **Automaxx**<sup>®</sup> ITEM# KHCRA

### The Secret Weapon for Pocket-Hole Construction

The Kreg<sup>®</sup> Right Angle Clamp makes projects with 90° joints faster and easier by giving you the helping hand you need to hold the parts in position as you drive in the screws. Just slip the pin on the Right Angle Clamp into a pocket hole, close the clamp, and it draws the mating pieces tightly together. The swiveling clamp pad opposite the pin grabs the mating piece securely.

Thanks to Automaxx<sup>®</sup> Auto-Adjust Technology, the Right Angle Clamp adjusts to match the material automatically with a simple squeeze of the handles.



#### CLAMP USING THE POCKET-HOLE

The steel pin on one arm of the clamp is shaped to fit snugly into a pocket hole, securely anchoring one workpiece against the other for easy assembly. Just drive a screw in an adjacent pocket hole while the Right Angle Clamp holds the pieces for you.

#### SWIVEL PAD

On the arm opposite the pin, this clamp features a pad capable of swiveling to adjust to the dimensions of your material, so you can count on solid clamping without a chance of the joint shifting.

#### ULTRA WIDE REACH

Whether you're joining two thin drawer sides or thicker materials to frame an outdoor project, the Right Angle Clamp opens wide to get the job done.

#### USE TWO CLAMPS

Many woodworkers find it handy to use two Right Angle Clamps when assembling large workpieces. Place a clamp on each end to hold the parts while you drive screws in the remaining pocket holes.



## Classic Face Clamps

Flush Kreg Joints™ In No Time

Classic Face Clamps™ are designed for creating perfectly flush Kreg Joints™. They work great for lots of other shop and project tasks that require solid clamping without marring. These clamps feature large clamp pads that distribute clamping force evenly, and hold pieces flush during assembly. When used in Kreg Joinery™, the extra-large clamp face gets positioned on the “show” side of the joint.

Classic Face Clamps are available in two sizes: 2" (51mm) reach and 3" (76mm) reach. Both have a simple screw that adjusts the clamp to match material thickness, plus comfortable padded handles. Both are compatible with the Kreg Jig® R3's Clamp Pad Adapter.



### Classic 2" Face Clamp

2" (51mm) reach; clamps materials up to 2 1/4" (57mm) thick. This easy-to-use, compact clamp fits easily into tight spaces.



ITEM# KHC-MICRO

### Classic 3" Face Clamp

3" (76mm) reach; clamps materials up to 2 3/4" (70mm) thick. Offers increased reach and clamping capacity.



ITEM# KHC-PREMIUM

## 90° Corner Clamp

Self-squaring joints, quick and easy

The 90° Corner Clamp features a self-squaring design that aligns joints at a 90° angle. It also includes an L-handle for quick adjustment. The swivel head can easily adjust for materials up to 1 1/4" (32mm) thick. A large, heat-treated steel clamping surface with nickel plating protects soft woods against clamp imprint.



ITEM# KHC-90DCC



## Auto-Adjust Bar Clamps

with Automaxx®

Auto-Adjust Clamping Technology Meets Bar-Clamp Versatility

When you want the durability and auto-adjust convenience of Automaxx® clamping, but you need more clamping capacity, turn to Auto-Adjust Bar Clamps with Automaxx® Technology. Just like other Kreg Clamps, these bar clamps adjust automatically when you change material sizes.

Just slide the clamp jaws against your workpiece, and then squeeze the handles. Automaxx® Technology does the rest, closing the clamp with predictable, dependable clamping pressure every time. That clamping pressure is easy to regulate, as well, thanks to a simple thumbscrew that dials in the pressure you need, from gentle to highly powerful clamping.

Auto-Adjust Bar Clamps are available in three lengths—8", 16", 24"—to suit a variety of project needs. Whether the job requires holding large pieces during assembly, keeping workpieces in place on your bench, or any number of other project processes, Auto-Adjust Bar Clamps are up to the task.



Auto-Adjusts to match material thickness



Sliding clamp jaw moves to any position on bar

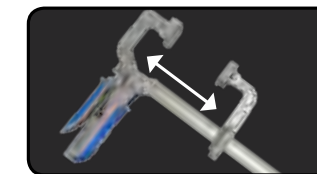

Available in three different capacities to match your needs



Easy-to-Regulate clamping pressure adds versatility



Padded jaws grip securely without marring



KSC24 Bar Clamp shown

COMING SOON!

## Bar Clamps:

KSC8	KSC16	KSC24
<p><b>8"</b> (203mm)</p> <p>The KSC8 Bar Clamp has an 8" (203mm) clamping capacity.</p>	<p><b>16"</b> (152mm)</p> <p>The KSC16 Bar Clamp has a 16" (152mm) clamping capacity.</p>	<p><b>24"</b> (609mm)</p> <p>The KSC24 Bar Clamp has a 24" (609mm) clamping capacity.</p>



## Clamp Table™ with Automaxx®

ITEM# KCT-COMBO

### The Ultimate Clamping Solution For Woodworkers and Do-It-Yourselfers

The Clamp Table is the ultimate clamping solution for Kreg Joinery™ and works with the entire family of Clamp System components. Now, this versatile table is even better with the addition of Automaxx® Clamping.

If you've ever struggled to get perfectly flush Kreg Joints™, failed to get your clamps positioned exactly where you need them, or needed an extra set of hands around the workshop, the Clamp Table is the perfect solution.

Made from glue-resistant melamine, this large 21¼" (552mm) x 33¾" (857mm) work surface is perfect for sanding, sawing, drilling, routing, joining, and almost any other woodworking task.

Available two ways: As a complete system with a heavy-duty stand, or with everything except the stand.



#### SPECIFICATIONS

##### Clamp Table™ with Automaxx®

- Large 21¼" (552mm) x 33¾" (857mm) clamping surface.
- Glue-resistant melamine surface.
- Clamp Trak™ on two sides of the table provides endless flexibility.
- Clamp Blocks™ allow for fast, accurate, and consistent registration of work pieces.
- Can be used for a variety of woodworking functions, including sanding, routing, and layout.

##### Multi-Purpose Shop Stand

- Heavy-duty 12- & 16-gauge steel
- Adjustable: 31" (787mm) to 39" (990mm)
- Four stable leveling feet
- Highly durable powder-coated steel
- Fast and easy assembly

#### Make it Mobile



##### Heavy-Duty Casters

Add mobility to your Multi-Purpose Shop Stand. Includes four heavy-duty casters. Dual-locking mechanism protects against caster roll and pivot. Weight capacity is 150 lbs. each. Includes all necessary hardware.

ITEM# PRS3090



The Clamp Table holds workpieces securely and provides solid support for Kreg Joinery™, drilling, sawing, sanding, routing, and more!

#### Top and Stand Also Available Individually



ITEM# KCT

##### Clamp Table with Automaxx®

The Clamp Table™ is the ultimate clamping solution for Kreg Joinery™, and works with the entire family of Clamp System™ components. If you've ever struggled to get perfectly flush Kreg Joints™, failed to get your clamps positioned exactly where you need them, or needed an extra set of hands around the workshop, the Clamp Table™ with Automaxx® is the perfect solution.



ITEM# KRS1035

##### Multi-Purpose Shop Stand

The Kreg® Multi-Purpose Shop Stand is the perfect foundation for all Kreg table top solutions, including the Clamp Table™ and the Precision Router Table Top. You can also use it to create a custom tool or work stand for your shop. Includes four (4) leveling feet and assembly hardware. 20" (508mm) x 28" (711mm)

## Universal Clamp Trak™ Kits

### Turn Any Workbench—New Or Existing—Into A Hardworking Clamping System

Create your own clamping system that securely holds workpieces in place on your bench as you work. The Universal Clamp Trak™ Kit accepts Kreg® Bench Clamps (sold separately) that you can use to lock workpieces down while creating Kreg Joints™, sanding, routing, drilling, and much more. The long Traks™ allow you to position one, two, or more Bench Clamps exactly where you need them.

Kits are available in two sizes—27" x 45" (686mm x 1143mm) or 27" x 69" (686mm x 1752mm)—that you can mount to an existing workbench, or incorporate into a new bench you are building. That way, you can create a clamping system that suits your needs and your space.

#### Features:

- Heavy-duty anodized aluminum construction
- .695" (17mm) thickness allows Trak™ to sit just below a ¾" (19mm)-thick surface
- Works with Kreg® Bench Clamps™
- Works with Clamp Blocks™



Cutting

Sanding

Routing

General Hold Down

#### Universal Clamp Trak™ Kit

##### 27" x 45" (686mm x 1143mm)

Item# KKS2745

- Fits workbenches 30" x 48" (762mm x 1219mm) and larger

Note: Kit is compatible with Kreg Universal Bench (page 56)—20" x 44" (508mm x 1117mm) or 28" x 44" (711mm x 1117mm)



(1) 27" (686mm) Trak™  
(1) 45" (1143mm) Trak™  
Mounting Hardware

#### Universal Clamp Trak™ Kit

##### 27" x 69" (686mm x 1752mm)

Item# KKS2769

- Fits workbenches 30" x 72" (762mm x 1829mm) and larger

Note: Kit is compatible with Kreg Universal Bench (page 56)—20" x 64" (508mm x 1625mm) or 28" x 64" (711mm x 1625mm)



(1) 27" (686mm) Trak™  
(1) 69" (1743mm) Trak™  
Mounting Hardware

### Two easy ways to mount your track

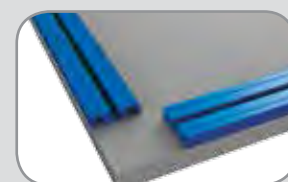

#### Surface Mount

Simply mount Traks™ to a ¾" (19mm)-thick or thicker surface.

- Creates raised edges that can be used as workpiece stops and squaring aids.
- Adds capacity to Bench Clamps™
- Works with any surface—single or multiple layer

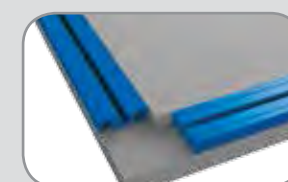

#### Flush Mount

Mount Traks™ to a ¾" (19mm)-thick or thicker surface, then add a ¾" (19mm)-thick layer to create a flush surface. Or, rabbet edges of bench top, and then mount Traks™

- Allows unobstructed bench top surface
- Retains standard Bench Clamp™ Capacity
- Allows use of Kreg Clamp Blocks™

## Clamp System™ Components



ITEM# KBK-IP

#### Clamp Plate

Add a clamping station almost anywhere you need one. Includes plate and mounting hardware. The Clamp Plate is compatible with Kreg® Bench Clamps™.

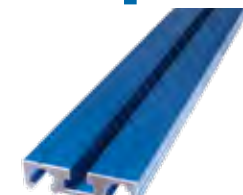

ITEM# KKS1020

#### Clamp Trak™

The Clamp Trak™ lets you turn an entire workbench or sawhorse into a clamping station. Includes one 33¾" (857mm) aluminum extrusion. Clamp Trak™ is compatible with Kreg® Bench Clamps™.



ITEM# KKS1030

#### Clamp Block Set™

The Clamp Block Set™ lets you quickly and accurately register your workpieces and align your project for quick and easy squaring. Especially useful for face-frame construction. Made from durable, impact-resistant plastic. Includes 5 plastic blocks and mounting hardware.



ITEM# KKS1070

#### Bench Dogs

Made from ultra-durable, glass-reinforced nylon, Bench Dogs are great clamping aids for your workbench. They come with sticky rubber Bench Brakes that keep workpieces from slipping. Attach Bench Brakes to the Bench Dogs or directly to dog holes in your work surface. Includes four Bench Dogs.



# ROUTING SOLUTIONS

Router table Systems	41-44
Routing Accessories	45-46
Beaded Face-Frame System	47



## Precision Router Table System ITEM# PRS1045

### The All-In-One Solution For Precision Routing

The new Kreg® Precision Router Table System combines unmatched versatility with incredible adjustability and ease of setup to take your woodworking projects to the next level. This powerful system offers a one-of-a-kind T-square style fence, a large, durable table top, and a durable steel stand that work together to create a router table that meets all of your precision-routing needs.

Our exclusive Easy-Slide™ surface, Precision Insert Plate with Level-Loc Reducing Rings and uniquely designed accessories ensure that you get the best possible routing experience on each and every pass.



#### System Includes:

- Multipurpose, Self-Squaring Router Table Fence System
- High-Performance Table Top with Precision Insert Plate System
- Heavy-Duty, Adjustable Steel Stand
- Fence Micro-Adjuster



#### Make it Mobile



**Heavy-Duty Casters**  
Add mobility to your Multi-Purpose Shop Stand. Includes four heavy-duty casters. Dual-locking mechanism protects against caster roll and pivot. Weight capacity is 150 lbs. each. Includes all necessary hardware.

ITEM# PRS3090

#### FENCE FEATURES

##### A TABLE SAW FUNDAMENTALS

Table saw-style T-square adjustment system that ensures the fence will always stay parallel to the miter-gauge slot. The fence adjusts easily with just one hand, and locks firmly in place with dual locks.

##### B UNPARALLELED PRECISION

Magnified measuring system with an adjustable measuring scale allows accurate setup with any bit. Included Micro-Adjuster allows you to dial in precision measurements exactly.

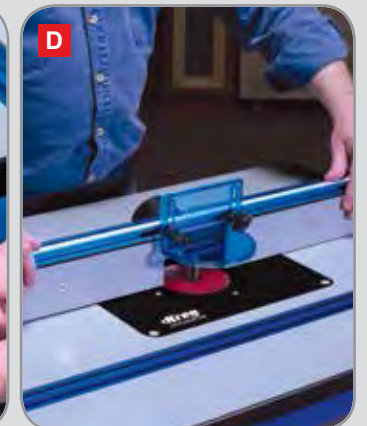
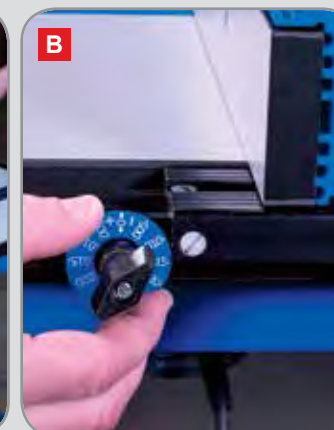
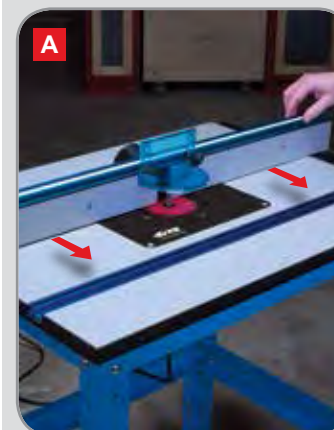

##### C BUILT-IN JOINTING FEATURE

Two jointing rods included with system. Just slide them into position behind the outfeed fence face, and the fence doubles as a jointer for putting perfect edges on boards.

##### D INDEPENDENT ADJUSTABLE FACES

Sliding fence faces can be positioned exactly where needed to provide workpiece support close to the bit, and to maximize chip collection into the fence's built-in dust port.



# Precision Router Table System

ITEM# PRS1045

## TABLE FEATURES

### LOW-FRICTION EASY-SLIDE™ SURFACE

Durable, high-pressure laminate skin offers a low-friction Easy-Slide™ surface. Thick edgbanding protects the top against bumps and abrasions. Top is predrilled for holes for the Precision Insert Plate Levelers.



### VERSATILE COMBINATION TRAK

Multipurpose trak works with standard 3/8" (10mm) x 3/4" (19mm) miter gauge guide bars. It also accepts Featherboards and other accessories, and is made from durable anodized aluminum.



### PRECISION COMBINED WITH DURABILITY

Four Precision Insert Plate Levelers allow you to set the plate flush for smooth, accurate routing. Steel reinforcing struts keep the 1" (25mm)-thick MDF table flat, even under the weight of heavy routers and lifts.

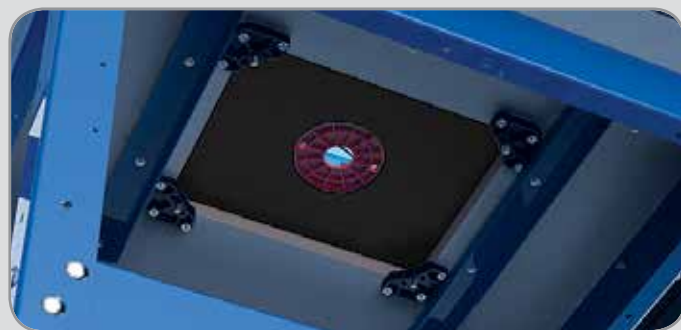

### FEATURE-PACKED INSERT PLATE

The heavy-duty 3/8" (10mm) x 9 1/4" (235mm) x 11 1/4" (298mm) compression-molded insert plate handles large routers with ease. Level-Loc Reducing Rings lock in level and flush with the plate surface using the included ring wrench. A brass starter pin ensures controlled bit contact during freehand routing.



## SPECIFICATIONS

Plate Opening Dimensions	Table Surface	Fence Length	Fence material	Overall Dimension	Weight	Multi-Purpose Shop Stand
3/8" x 9 1/4" x 11 1/4" (609mm x 235mm x 298mm)	24" x 32" (609mm x 813mm) with a 1"-thick (25mm) core	36" (914mm)	Heavy-duty anodized aluminum	36 1/2"H x 37 1/2"W x 25 1/2"D (927mm)H x (952mm)W x (648mm)D	85 lbs. (39kg)	<ul style="list-style-type: none"> <li>• Heavy 12- &amp; 16-gauge steel construction</li> <li>• Adjustable height: 29" (737mm) to 35" (889mm)</li> <li>• 4 stable leveling feet</li> <li>• Durable powder-coated finish</li> <li>• Fast and easy assembly</li> </ul>

## BUYING OPTIONS



ITEM# PRS1045

### Precision Router Table System

This powerful system offers a large, durable table top, a one-of-a-kind T-square style fence, and a durable steel stand that work together to create a router table that meets all of your precision-routing needs. Includes Item #s PRS1025, PRS1015, and KRS1035.



ITEM# PRS1025

### Precision Router Table Top

This 24" x 32" table top has a 1"-thick MDF core that absorbs vibration and offers mass to help create a stable router table. A tough Easy-Slide™ surface, made from high-pressure laminate, helps workpieces glide easily. Underneath, steel-reinforcing struts ensure that the table will stay flat to provide years of dependable service.



ITEM# PRS1015

### Precision Router Table Fence

This anodized-aluminum fence features a table saw-style T-square adjustment system that ensures the fence will always stay parallel to the miter-gauge slot. The fence adjusts easily with just one hand, and locks firmly in place with dual locks: a large paddle lock on the infeed end, and a quarter-turn lock on the outfeed end that prevents fence deflection.



ITEM# KRS1035

### Multi-Purpose Shop Stand

Perfect foundation for all Kreg table top solutions, including the Clamp Table™ and the Precision Router Table Top. You can also use it to create a custom stand for your shop. Includes four (4) leveling feet and assembly hardware. 20" (508mm) x 28" (711mm)

# Precision Benchtop Router Table

ITEM# PRS2100

## Full-Size Router Table Capability In A Portable Package

The Precision Benchtop Router Table offers features that give it the capability of a full-size, industrial router table in a portable package.

The table top is made from an edgbanded, vibration- and noise-resistant MDF, and features an Easy-Slide™ skin. The skin is constructed from a high-pressure laminate, which allows you to easily slide workpieces across the surface.

The Precision Router Table Insert Plate measures 3/8" x 9 1/4" x 11 1/4" to support even the biggest routers, and it features Level-Loc Reducing Rings. These rings twist into place and lock in flush with the plate surface every time.

The heavy-duty aluminum fence features quarter-turn locking levers. They allow quick fence adjustment and confident locking, plus they are sized so they're easy to use but stay out of the way behind the fence. The fence also has independent sliding faces that provide increased workpiece support around the bit, and allow the table to be used as a vertical jointer.



Lightweight yet durable, compact yet feature-packed, this router table is perfect for anyone who needs a router table on the jobsite or for anyone who wants all the features of a full-sized router table in a portable package.

Insert Plate Dimensions	Table Surface	Fence Length	Fence material	Overall Dimension	Weight
9 1/4" (235mm) x 11 1/4" (298mm) x 3/8" (9mm) with Level-Loc Reducing Rings	16" x 24" x 1" (406mm x 609mm x 25mm)	24" (610mm)	Aircraft-grade aluminum Anodized for easy cleanup	20"H x 28 1/2"W x 20 1/4"D (508mm)H x (717mm)W x (514mm)D	26 lbs. (12kg)

## FEATURES

### A EASY-SLIDE™ ROUTER TABLE TOP

This router's tabletop features the same Easy-Slide™ skin, made from the same impact-resistant, high-pressure laminate that is used on our full-size router table. This skin allows workpieces to glide across the table's surface easily.

### B BUILT FOR INDUSTRY PROFESSIONALS ON-THE-GO

This portable router table is built to withstand years of heavy use on the job site. It features a rugged steel foundation, four hard-wearing rubber feet, a tough tabletop made from impact-resistant surface, and a rigid aluminum fence, that are all built with mobile professionals in mind.



### C BUILT-IN JOINTER

Fully-independent fence faces and depth-setting rods quickly turn your portable router table into a vertical jointer. Depth rods are stored on the fence and can be positioned behind the faces, allowing for jointing depth adjustments of 1/8" (2mm) and 1/2" (.80mm).

### D FULL-SIZE LEVEL-LOC INSERT PLATE & LEVELERS

This full-size insert plate is the same compression-molded plate used in the large Kreg® router table, which means you never have to compromise on functions or features. The plate is equipped with Level-Loc Reducing Rings that simply twist into place and lock in level and flush with the plate surface every time. Three rings are included: 1" (25mm), 1 1/8" (20mm) (for use with universal-style guide bushings), and 2 1/8" (16mm). The plate is mounted using Kreg® Precision Insert Plate Levelers, making it easy to set the plate exactly flush with the table surface.



## Precision Router Table Insert Plate

Equip your router table with an insert plate that offers the features and durability you demand. The Precision Router Table Insert Plate is made from compression-molded phenolic, which is 30% stronger, and 20% more rigid than standard phenolic, meaning it starts out flat and stays flat, even when used with a large, heavy router.

The plate is equipped with Level-Loc Reducing Rings that simply twist into place using an included ring wrench to lock in level and flush to easily change the size of the opening around the router bit. Three Level-Loc Rings: 1" (25mm), 1½" (30mm) for use with universal-style guide bushings, and 2½" (67mm) rings are included.



### FEATURES

#### A LEVEL-LOC REDUCING RINGS

Change the size of the opening around your bit easily using these rings that simply twist into place and lock-in level and flush with the plate surface every time. Includes three rings: 1" (25mm), 1½" (30mm) (for use with universal-style guide bushings), and 2½" (67mm).

#### B WORKS WITH MOST ROUTERS

This 9¼" (235mm) x 11¾" (298mm) x ¾" (10mm) thick plate is designed to easily accept most routers, and is built tough to resist sagging, with even the largest, heaviest routers.

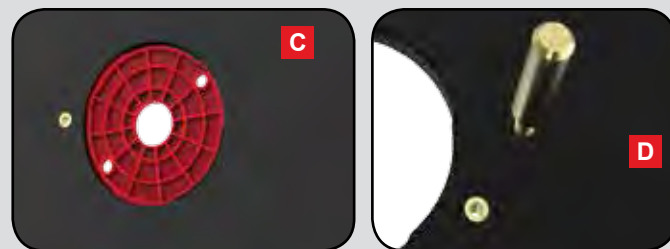

#### C MOLDED-IN ALIGNMENT MARKS

The undrilled Insert Plate comes without pre-drilled holes, unlike so-called "universal" plates. Instead, it has molded alignment marks on the underside that make it extremely easy to center and mount your router.

#### D REMOVABLE BRASS STARTING PIN

This removable brass starting pin gives you the safety and control you need while routing freehand—without a fence to guide the workpiece past the bit—by providing a surface to rest your workpiece against before you pivot the workpiece against the bit.

### The Precision Router Table Insert Plate is available in three styles:

#### ITEM# PRS4034

Insert Plate predrilled to match the hole pattern of the Triton MOF001 and TRA001. (Also fits the Porter-Cable 7500 series by enlarging the mounting holes.)

**Includes:** Precision Router Table Insert Plate, three Level-Loc Reducing Rings, ring wrench, brass starting pin, router mounting screws, ring wrench.

#### ITEM# PRS4036

Insert Plate predrilled to match the Porter-Cable 690 and 890, as well as the Bosch 1617.

**Includes:** Precision Router Table Insert Plate, three Level-Loc Reducing Rings, ring wrench, brass starting pin, router mounting screws, ring wrench.

#### ITEM# PRS4038

Insert Plate without predrilled holes. Has shallow "starter holes" molded into the underside for popular router patterns, as well as a molded centering pattern.

**Includes:** Precision Router Table Insert Plate, three Level-Loc Reducing Rings, ring wrench, brass starting pin, ring wrench.

## Heavy-Duty Casters

### ITEM# PRS3090

Add mobility to your Multi-Purpose Shop Stand, Precision Router Table System, Clamp Table, or Universal Bench with these heavy-duty, 150 lb.-capacity casters. The 3" wheels are made from rubber to roll easily, but stay put when the casters are locked. The casters feature a dual-locking mechanism that prevents them from rolling or pivoting by simply flipping a large lever.



## True-FLEX™ Featherboard

The True-FLEX™ Featherboard gets its name from the careful engineering that went into its design. Many Featherboards on the market today apply too much pressure or not enough pressure to the workpiece, which results in imperfect cuts and less-than-safe operation.

The True-FLEX™ Featherboard provides a consistent and optimum pressure, and will stand up to years of heavy use in your woodshop. The Featherboard is made from an extremely durable plastic composite body and includes a Wedge-Lock™ System that allows the Featherboard to be secured to a variety of shop tools without the need for additional hardware.

Whether you're using a miter-slot or a T-slot, working on a table saw or a router table, the Wedge-Lock™ System adjusts accordingly and lets you work with confidence. Designed for use in standard ¾" (10mm) x ¾" (19mm) miter slot.

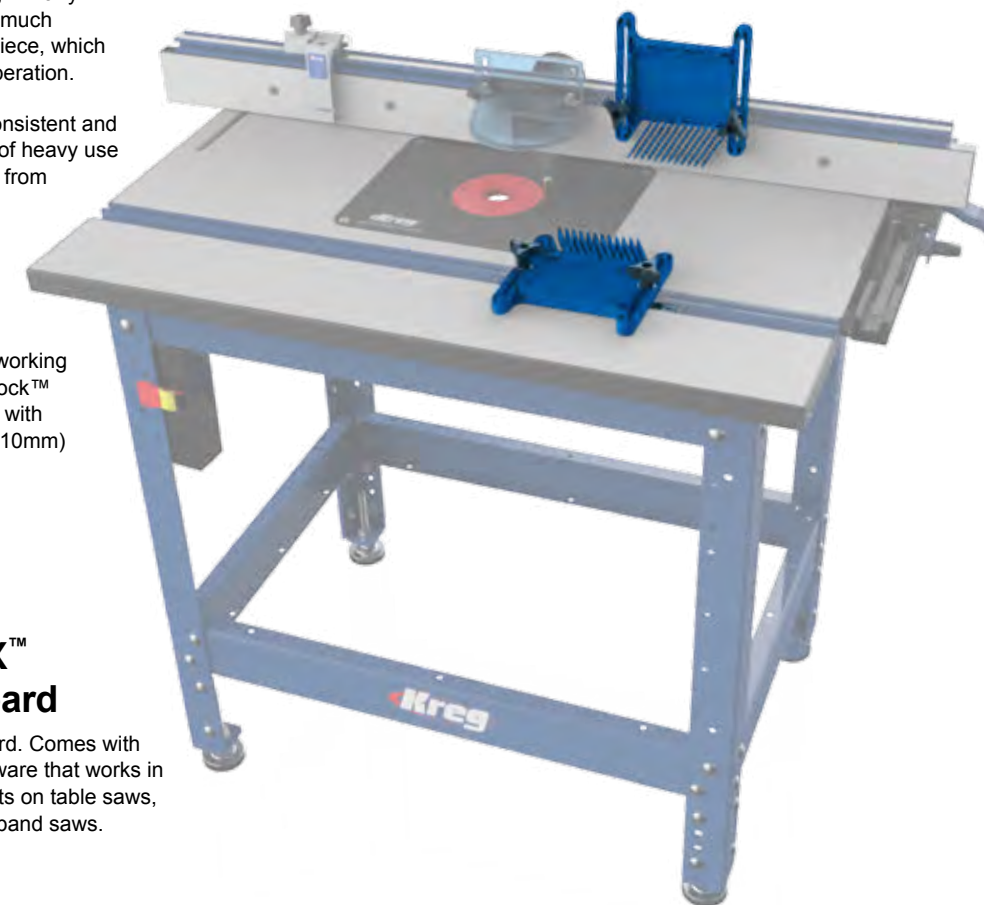

ITEM# PRS3010

### True-FLEX™ Featherboard

Single Featherboard. Comes with Wedge-Lock hardware that works in T-slots or miter slots on table saws, router tables, and band saws.



ITEM# PRS3020

### True-FLEX™ Featherboard Twin Pack

Comes with an extended version of the Wedge-Lock hardware, perfect for stacking. When used together, they provide additional support for tall workpieces, resulting in higher-quality cuts.



True-FLEX™ fingers apply optimum pressure to your workpiece. Unique wedge-lock hardware works in miter slots on tablesaws, router tables, and band saws.



Vertical and horizontal positioning demonstrates wedge-lock miter slot and T-slot compatibility.

## Precision Router Table Insert Plate Levelers

### ITEM# PRS3040

These unique levelers are the easiest way to add an insert plate to your shop-built router table. They eliminate the need for a supporting rabbet and feature a unique bottom-mount design that includes eight adjustable points of contact, four-corner lock-downs for stability, and locating tabs for easy installation.



Plate Levelers mount easily to the underside of the table. Eliminates the need for a rabbeted opening.



Two adjustable set screws on each Leveler make it easy to the router plate flush with the table surface.



## Routing Accessories

### Precision Router Table Stop

ITEM# PRS7850



Bring greater accuracy and repeatability to your Precision Router Table with this uniquely-designed stop. Features a low-profile, aluminum design, made to flip out of the way when not in use. The included Precision Lens Cursor gives you a clear and accurate view of the fence's tape.

Compatible with Kreg® Precision Router Table and Precision Benchtop Router Table.



Design allows the stop to flip out of the way when not in use.



Get extra precision and unmatched repeatability for stopped dados & tenons.

### Multi-Purpose Router Table Switch

ITEM# PRS3100



Add safety and convenience to your Precision Router Table with this incredibly handy power switch. This unique switch features a two-plug design to control two independent devices at once, Key-Lok™ to eliminate accidental power-on, and an 8-foot long (2438mm), heavy-duty, 14-gauge power cord. This switch makes a perfect companion to our Precision Router Table and Precision Benchtop Router Table.



Key-Lok™ eliminates unintentional power-on.



Dual-plug design controls two independent devices at once.

### Level-Loc Reducing Rings 5-Piece Set

ITEM# PRS3050



This five-piece set of Level-Loc Reducing Rings fits the Precision Router Table Insert Plate (see page 44), allowing you to customize the size of the opening around the bit.



Includes rings with 3/4", 1 1/8", 1 1/4", and 2 1/8" openings, plus one "blank" ring



Works with Kreg® Precision Insert Plate

### Precision Router Table Setup Bars

ITEM# PRS3400



These innovative setup bars feature three unique ways to ensure your projects get the precision they truly deserve. This set includes seven setup bars stored in a portable protective case. Sizes: 1/8" (3mm), 3/16" (4mm), 1/4" (6mm), 5/16" (8mm), 3/8" (10mm), 7/16" (11mm), 1/2" (12mm).



Concave step on the bottom of each setup bar straddles router bit or saw blade for precise height adjustment



Step on the end of each setup bar precisely sets fence offset distances on the router table or table saw

## Precision Beaded Face-Frame System

ITEM# PRS1200

### Beaded Face Frames, the Kreg® Way!

Beaded face frames are a great way to add detail, richness, and value to your cabinetry work. The Precision Beaded Face-Frame System works in conjunction with your full-size router table to serve as the fastest, easiest, and most affordable way to build beaded face-frames in a home shop.

Through a process of precise notching of the rails and stiles, the Precision Beaded Face-Frame System simplifies standard beaded face-frame construction by eliminating the need to make intricate cuts on a table saw, fit and refit miters, or spend thousands of dollars on a large specialized machine. The end result is higher-quality, more-consistent results in less time and with less effort than before.

#### System Includes:

The system comes complete with a Kreg® 1/4" (6mm) x 1 1/2" (38mm) notching bit, Kreg® 1/4" standard beading bit, Kreg® 1/4" precision setup bar, and everything else you need to get started. Additional accessories, including unique beading bits and notching bits, are available for a wide variety of projects.

#### How It Works:



1) Use the control arm and smooth sliding base to plunge the stiles into the special notching bit.



2) Use the Precision Router Table Stop to ensure perfectly placed notches on the rails.



3) Switch to your standard routing fence and included beading bit to apply a decorative bead.



4) Use Kreg Joinery™ to secure the rails to the notched stiles. Glue is optional.



5) Done! Now it's time to sit back and enjoy the beauty custom-made beaded face frames bring to your home.



#### Included Bits:

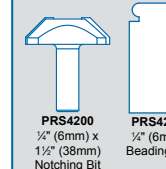

#### FEATURES

##### A SLIDING BASE

The sliding base of the Precision Beaded Face-Frame System features 20 internal stainless steel ball bearings that guarantee smooth operation over the long haul.

##### B CONTROL ARM

The handle can be connected to the Precision Beaded Face-Frame System with or without the Control Arm. The arm provides improved control, smooth operation, and reduces the force necessary to plunge the workpiece into the bit.

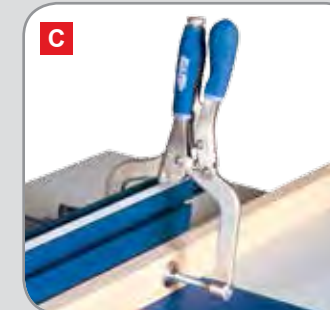
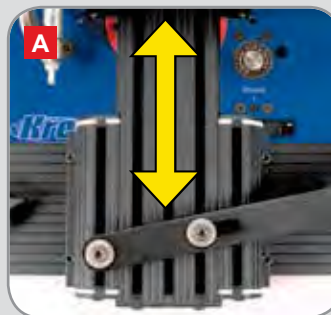

##### C INTEGRATED CLAMP

This heavy-duty clamp holds your workpieces firmly in place. Features a quick-release handle and adjustability for stock thickness.



##### D ROUTER TABLE STOP

The included Precision Router Table Stop lets you repeat cuts at the exact same measurement again and again. It features a Precision Lens Cursor for magnified accuracy and can be conveniently flipped out of the way when not in use.

#### OPTIONAL PROFILES

Searching for a more unique look? We have all the profiles you need to get the job done right. These special bits are designed for use with the Precision Beaded Face-Frame System.

Each bit features high quality 1/2"-shank construction along with high-grade carbide tips for extreme durability. At right are our three beading bits and four standard notching bits. Contact customer service at 1-800-447-8638 or visit [www.kregtool.com](http://www.kregtool.com) for more information.

#### Beading Bits

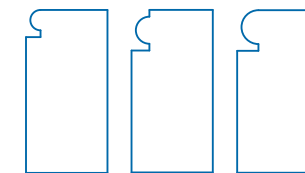

PRS4250 1/4" (6mm) Bit  
PRS4255 5/16" (8mm) Bit  
PRS4260 3/8" (10mm) Bit

#### Notching Bits

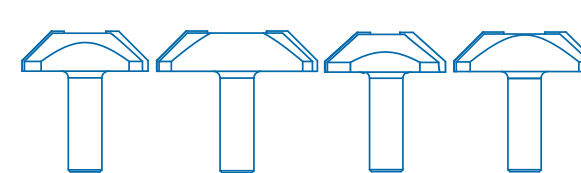

PRS4200 1/4" x 1 1/2" (6mm x 38mm)  
PRS4205 1/4" x 2" Bit (6mm x 50mm)  
PRS4210 3/8" x 1 1/2" (10mm x 38mm)  
PRS4215 3/8" x 2" (10mm x 50mm)





## Cabinet Hardware Jig ITEM# KHI-PULL

### The Easy, Accurate, Repeatable Way to Install Knobs and Pulls

Whether you're installing one new knob or dozens of drawer pulls, the Cabinet Hardware Jig takes the guesswork out of the process, ensuring accuracy and consistency every time. A moveable edge guide and built-in measuring scales (with imperial and metric markings) make it easy to position knobs precisely.

Plus, the Cabinet Hardware Jig features moveable, hardened-steel drill guides that lock in place to align with common hole-spacing measurements for cabinet knobs and pulls. The guides make it simple to drill straight, accurately positioned holes. The jig works with almost any style of knob or pull, too, making it exceptionally versatile.

#### Specifications:

- Construction: Polycarbonate/ABS
- Drill guides: two 3/16" guides, moveable, with locking nuts
- Drill guide material: Hardened steel
- Drill guide spacing: 0", 2½", 3", 3½", 4", 4½", 5", 64mm, 96mm, 128mm
- Edge guide to hole-center spacing: 1" to 5" (25mm-127mm)
- Measuring scales: Imperial and metric

#### Includes:

- (1) Jig Base and (1) Edge Guide
- (2) Drill Guides with knurled nuts
- (2) Non-slip pads
- (2) T-knobs and bolts
- (1) Owner's Manual with complete instructions

**NOTE:** 3/16" (4.5mm) drill bit required. Not Included.



## HARDWARE INSTALLATION SOLUTIONS

Cabinet Hardware Jig	49
Concealed Hinge Jig	50
Shelf Pin Jig	51
Drawer Slide Jig	52

#### A VERSATILE

Works with almost any knob or pull style, and has drill-guide locating stops in imperial and metric measurements.

#### B EASY

Easily set the jig to locate knobs or pulls exactly where desired.



#### C ACCURATE

Drill straight mounting holes accurately using built-in hardened-steel drill guides that keep the bit straight.

#### D REPEATABLE

Confidently mount hardware after drilling the holes, knowing that it will fit correctly every single time.



## Concealed Hinge Jig

ITEM# KHI-HINGE

### The Easy, Accurate, Repeatable Way to Install Cabinet Hinges

The Concealed Hinge Jig takes the guesswork out of installing cabinet doors using concealed hinges. With this easy-to-use jig, you get drill-press accuracy using an ordinary hand drill. The jig ensures accurate hinge alignment, for doors that fit perfect and work well. Plus, the Concealed Hinge Jig comes with a high-quality carbide-tipped bit with a built-in stop collar that ensures smooth, clean holes that are always drilled to the perfect depth.

The Concealed Hinge Jig consists of a glass-filled nylon base with a hole that receives a drill guide. Indexing cams ensure that the jig positions the bit to drill a hole at the required offset—which is dictated by each hinge—and a built-in stop collar ensures that the cup depth is correct every time. A pair of smaller holes also allow drilling perfectly-positioned holes for the hinge mounting screws, ensuring that the hinge will fit accurately every time.

#### Specifications:

- Construction: Glass-filled nylon
- Hinge compatibility: 35mm cup-style concealed hinges
- Hinge offset: 3mm, 4mm, 5mm, 6mm
- Drill bit, four-cutter carbide tipped with stop collar
- Hinge offset from door end: 2" (50mm) to unlimited

#### Includes:

- (1) Jig base with index cams
- (1) Drill guide
- (1) 35mm carbide-tipped drill bit
- (1) Stop collar with hex wrench
- (1) Owner's Manual with complete instructions

**NOTE: 1/16" (1.5mm) drill bit required for hinge-mounting screws. Not Included.**



#### A ADJUSTABLE

Setting the jig to the correct hinge offset is simple by using built-in indexing cams.

#### B EASY

Easily set the jig to position the hinge cup precisely, and then drill a hole to the perfect depth using any drill.



#### C ACCURATE

Drill holes for the hinge mounting screws, as well, using guide holes in the jig to ensure accurate results.

#### D REPEATABLE

Confidently install hinges that fit perfectly every single time for doors that fit right and look great.

#### 35mm Concealed Hinge Bit:

This high-quality carbide-tipped drill bit is the same one that comes with the Concealed Hinge Jig. It features four carbide cutters: Two large cutters that create a smooth, flat-bottomed hole, plus two spur cutters that shear the hole sides cleanly for a straight, smooth hinge cup. Stop collar not included.



ITEM#  
KHI-BIT

## Shelf Pin Jig

ITEM# KMA3200 / KMA3220

### Super. Simple. Shelving.

Whether you're adding shelf pin holes to an existing piece of furniture or building shelves from scratch, the Shelf Pin Jig is the perfect tool for the job. Unlike other shelf pin guides, the Shelf Pin Jig features hardened-steel drill guides that ensure precise and straight drilling, so you'll get level, wobble-free shelves.

The Shelf Pin Jig also includes a removable, dual-position fence that can be used to position holes either 1" or 2" (25mm or 50mm) from the edge, a locating pin that provides accurate spacing when you move the jig, and a jig extender that lets you connect multiple Shelf Pin Jigs together for high-speed production work. Available with either a 1/4" (6mm) or a 5mm brad point bit, and a depth collar that can be stored on the bottom side of the Shelf Pin Jig when not in use.

#### Includes:

Shelf Pin Jig, locating pin, jig extender, drill bit, depth collar, hex wrench, instruction manual, and (4) shelf pins.

#### Specifications:

- Dual-Position Fence, Adjustable (1" & 2") (25mm or 50mm)
- 32mm Hole Spacing



#### KMA3200

- Shelf Pin Jig with 1/4" (6mm) Bit

#### KMA3220

- Shelf Pin Jig with 5 mm Bit

DRILL GUIDE  
LIFETIME  
WARRANTY

#### A DURABLE

Hardened-steel drill guides ensure precise drilling. Accepts both 1/4" (6mm) and 5mm brad-point bits.

#### B REPEATABLE

A locating pin lets you confidently move the jig and reference last hole drilled.



#### C EASY

A built-in fence aligns with the edge of the workpiece to set the proper offset between the edge and the holes. The fence is removable for working inside a case.

#### D EXPANDABLE

An included jig extender can be used to connect two or more jigs together.

#### Additional Drill Bits:

Choose between 1/4" (6mm) and 5mm bits. 5mm bit features stepped design that allows it to fit precisely inside the Shelf Pin Jig's drill guides. Both bits include depth collar and allen wrench.



ITEM#  
KMA3210  
(1/4") (6mm)



ITEM#  
KMA3215  
(5mm)



# Drawer Slide Jig ITEM# KHI-SLIDE

## The Easy, Accurate, Repeatable Way to Install Drawer Slides

Whether you're updating cabinets or you're building a project from scratch, mounting drawers is always a challenge. The Drawer Slide Jig takes the guesswork out of installing drawer slides, ensuring drawers that fit perfectly and slide smoothly. The Drawer Slide Jig works with slides of all kinds—ball-bearing, epoxy-coated, and undermount—and can be used in face-frame and frameless cabinets.

This easy-to-use jig has two brackets that hold slides in position as you drill mounting holes in the cabinet. Built-in tabs make the brackets easy to align. With the face frame, or with designated marks on frameless cabinets. Of course, mounting slides inside the cabinet is only half the battle. That's why the Drawer Slide Jig brackets are reversible, as well, to support drawer boxes while mounting slides to the drawer.



### Specifications:

- Construction: Polycarbonate/ABS
- Dual-position positioning tabs
- Works with face-frame and frameless cabinets at least 14" deep
- Works with ball-bearing, epoxy-coated, and undermount slides

### Includes:

2 Brackets, 4 Upper/Lower Sliders—installed, Owner's Manual with complete instructions

#### A SOLID

Brackets clamp into place to align and support drawer slides for perfect installation. Also clamps to the outside of the cabinet to support the drawer box.

#### B ACCURATE

Tabs register the jig to the cabinet side and frame for foolproof positioning.

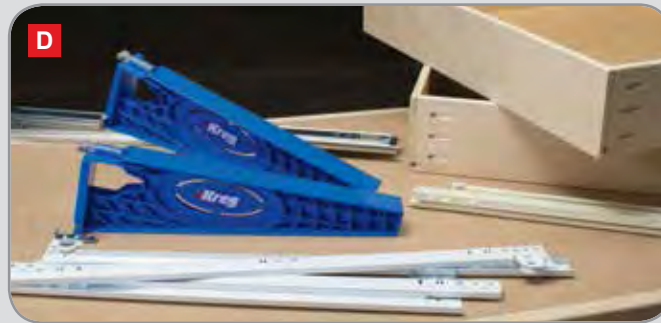

#### C ADAPTABLE

Works with face-frame cabinets, cabinets without frames, and on cases of other types, such as chests and dressers.

#### D VERSATILE

Installs ball-bearing, epoxy-coated, and undermount slides.



# WORKSPACE SOLUTIONS

Mobile Project Center

54-55

Universal Bench

56-57



# Mobile Project Center ITEM# KWS1000

Make any place your workspace

The Mobile Project Center gives you the freedom to work on projects wherever, whenever, and however you want. The Mobile Project Center sets up in no time, and can be used in multiple ways—as a workbench, a sawhorse, an assembly table, and a clamping station. Plus, the Mobile Project Center is a perfect companion for Kreg Joinery™. When not in use, the Mobile Project Center stows away quickly and stores flat.

- ✓ **Workbench** ✓ **Assembly Table**
  - ✓ **Sawhorse** ✓ **Clamping Station**
- All in One!**

Whether you work in the garage, out on the driveway or patio, or in a workshop, the Mobile Project Center is ready for whatever tasks you can throw at it. And if you need more work space, you can pair up two Mobile Project Centers: Attach them together with connecting keys to create a larger table surface, use the included support brackets and 2x4s to create a cutting platform, or throw a sheet of plywood on those 2x4s to create an extra-large work table.



**HEAVY-GAUGE STEEL LEGS** **STURDY TABLE BRACES** **LOAD CAPACITY 350 POUNDS** **VERSATILE EXPANDABLE DESIGN**



Organized storage trays hold hardware and small parts.

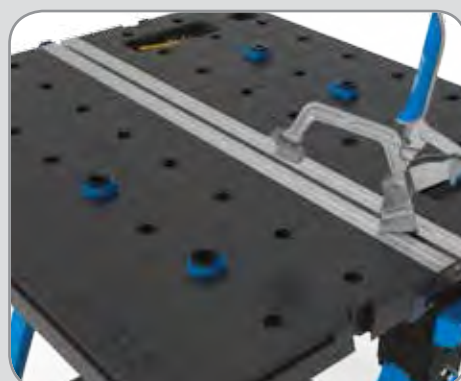

Hole pattern in top accepts included Bench Dogs and other accessories.



Included Trak™ bushings easily slide into the Trak™ to secure a 2x4 board and protect the Trak™ while cutting.



Clamp two ways: horizontally and vertically. Automaxx Technology adjusts clamp automatically so you can work faster.



Use the Bench Clamp like a vise to hold objects vertically as you work.



Use the Bench Clamp like a vise to hold objects vertically as you work.

## Make the Most of the Time You Have

When you've carved out some time in your schedule to work on projects, you want to make the time as productive as possible. The last thing you want is to spend half your time setting up and tearing down. The Mobile Project Center sets up in no time by simply opening the legs and lifting the tables up, so you can get to the tasks at hand. Then it folds down for storage just as fast. That means you can quickly set up anywhere you need to, and get to work. Plus, the Mobile Project Center makes your time more productive by helping to support, hold, and organize your project and your tools while you work.

### Work Modes



**WORKBENCH**  
Use 2x4s and plywood to create an extra-large bench surface.



**SAWHORSE**  
Fold the tables down to create a sturdy sawhorse.



**ASSEMBLY TABLE**  
Support projects on the large work tables during assembly.



**CLAMPING STATION**  
Clamp workpieces in multiple, easy ways so you have both hands free.

\*\*Requires two Mobile Project Centers

### Work on Projects Wherever, Whenever and However you Need To.



**Perfect for Every Project.**  
Offers multiple work modes for amazing versatility



**Increases Comfort While Working.**  
Raises work to a convenient height and allows access from all sides



**There When You Need It...**  
Unfolds easily to get you set up and working in no time



**Out of the Way When You Don't!** Folds flat for easy carrying and compact storage

### SPECIFICATIONS

- Large 27¼" x 31½" (70cm x 80cm) work surface
- Durable polypropylene tables withstand rugged use
- Locking table supports with easy-release tabs
- 350 lb. (158kg) load capacity when used alone with tables raised
- 2,200 lb. (997kg) load when paired and used as sawhorses (tables lowered)
- Comfortable 31½" (80cm) table height
- 17¾" x 26" (45cm x 66cm) storage shelf
- Large, non-slip feet for stable footing
- Folds to just 6½" (16.5cm) thick, weighs 40 lbs. (18kg)
- Expandable by pairing with a second Mobile Project Center

#### Includes:

- (1) Mobile Project Center
- (1) Bench Clamp with Automaxx® Technology
- (4) Kreg® Bench Dogs
- (2) Support Brackets
- (2) Trak Bushings
- (2) Connection Keys

#### Bonus Accessories





# Universal Bench

Any space. Any task. Any size.

Get organized and create great work space with the Kreg® Universal Bench. You can easily create a workbench, assembly table, tool stand, or outfeed table in a custom size to fit your space, your projects, and your needs. Just choose your height, width, and depth to create a custom workbench in one of 15 sizes—from 14" (355mm) x 14" (355mm) up to 64" (1600mm) x 64" (1600mm)—and two adjustable heights. Bench legs come with a code to access free, downloadable under-bench storage plans.

- |   |   |
|---|---|
| <b>KBS1005</b> - (4) 14" / 355mm rails  | <b>KBS500</b> - (4) 17¼" (438mm) to 23¼" (584mm) Legs |
| <b>KBS1010</b> - (4) 20" / 508mm rails  |   |
| <b>KBS1015</b> - (4) 28" / 711mm rails  | <b>KBS1000</b> - (4) 31" (787mm) to 39" (990mm) Legs  |
| <b>KBS1020</b> - (4) 44" / 1100mm rails |   |
| <b>KBS1025</b> - (4) 64" / 1600mm rails |   |



\* Image shown with optional Casters available separately  
\*\*Image shown with custom-built bench top and shelf

## SPECIFICATIONS

### Legs

- Sold in sets of 4
- 12-gauge steel
- Adjustable height (17¼" to 23¼" or 31" to 39") (438mm to 584mm or 787mm to 990mm)
- Includes leveling feet and assembly hardware

### Rails

- Sold in sets of 4
- 16-gauge steel
- Five lengths: 14" (355mm), 20" (508mm), 28" (711mm), 44" (1100mm), 64" (1600mm)

### Weight Capacity

- 600 lbs.

### Top/Shelf

- Supplied by user

## FEATURES

### HIGH-QUALITY HARDWARE

Zinc-coated carriage bolts lock into square holes for easy one-wrench assembly. They ensure that the bench remains rock-solid during use.



### ADJUSTABLE LEG LEVELERS & FEET

Legs offer 6" (152mm) of unlimited height adjustment so you can match the height of your table saw or another bench. Leg levelers accommodate uneven floors.

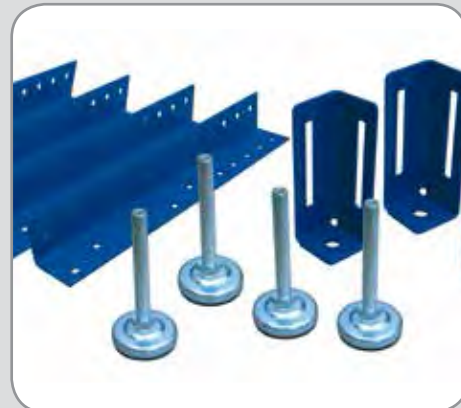

### PRE-DRILLED HOLES

Holes allow you to drop the upper rail down to add a storage shelf, drawers, create clearance for a vise, or add other custom touches to your bench.



### STURDY LEGS

Legs are made from heavy 12-gauge steel and are available in two adjustable heights: 17¼" to 23¼" or 31" to 39" (438mm to 584mm or 787mm to 990mm).

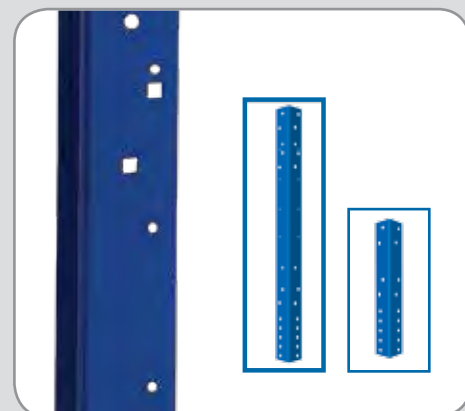

### 5 DIFFERENT RAIL LENGTHS

Now you can create the professional-quality bench you've always wanted for your garage or workshop, and customize it to the tasks you choose.



### CUSTOMIZE TO FIT YOUR NEEDS

Add a top, shelf, and other touches to complete your bench using your materials. A code to access downloadable storage plans comes with the legs.



# Universal Bench

Any space. Any task. Any size.

The Universal Bench makes it easy to create a workspace that suits your needs by allowing you to customize the bench height, width, and depth to fit your projects, your space, and your needs. The process is easy.

### Choose the Leg Height:

- Universal Bench legs are available in two heights. Both are adjustable.
- Standard-Height Legs are adjustable from 31" to 39"
  - Low-Height Legs are adjustable from 17¼" to 23¼"

### Choose the Rail Lengths:

- Universal Bench Rails are available in five lengths (14", 20", 28", 44", 64"). Choose one set of rails (four included) to establish the bench width you want. Choose another set to establish the bench depth.



1 Choose your Height

2 Choose your Width

3 Choose your Depth





## Education and Apparel

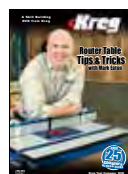

Mark Eaton  
#V09-DVD



Trim Carpentry  
#V07-DVD

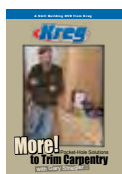

More Trim Carpentry  
#V10-DVD



**Basic Cabinetmaking Booklet**  
This 40-page booklet covers the basics of building professional face-frame cabinets with Kreg Joinery.  
#MD-CAB01 Basic Cabinetmaking



**The New Complete Guide to the Band Saw**  
This comprehensive book written by well-known band saw expert and author Mark Duginske.  
#BOOK-MDBSGB Band Saw Book



Cabinetmaking  
#V03-DVD



Router Tables  
#V06-DVD



Tables  
#V05-DVD



Kreg Short Sleeve T-Shirt

#BSSL Large  
#BSSXL X-Large



Kreg Long Sleeve T-Shirt

#BLSL Large  
#BLSXL X-Large



Kreg Baseball Cap

#BHAT One Size Fits All

## BUILD WITH KREG

### BUILD:

Find projects that will inspire you, along with the step-by-step instruction you need to turn that inspiration into reality.



### SHARE:

Turn the projects you've created into step-by-step plans and share them with the BuildSomething Community.



BuildSOMETHING.COM



BUILDSOMETHING.COM

## CONNECT WITH KREG



Find us on your favorite social media site!

## KREGTOOL.COM

Visit our website for videos, project plans, tool tips, the latest product news, and much more!

KREGTOOL.COM

## NEWSLETTERS

Get tips, tricks, and project ideas delivered straight to your inbox. Sign up for free at:

KREGTOOL.COM/NEWSLETTERS

## Kreg OWNERS' COMMUNITY

Join thousands of Kreg owners to ask questions, share advice, and see what others are building.

KREGJIG.NING.COM



Kreg Tool Company  
201 Campus Drive  
Huxley, IA 50124

PRSR STD  
U.S. Postage  
PAID  
Des Moines, IA  
Permit No. 589



ITEM# CATALOG-32

Replaces all previous catalogs

Product offering subject to  
change without notice

Kreg Solutions Vol. 32 - 2016  
Print date: July 2016

[www.kregtool.com](http://www.kregtool.com)  
[www.kregtool.ru](http://www.kregtool.ru)



# Custom Pocket-Hole Plug Cutter

USE KREG JOINERY™  
ANYWHERE BY HIDING  
THE HOLES WITH PERFECTLY-  
MATCHED, CUSTOM-MADE PLUGS



Place pocket holes in places where thought you couldn't  
by disguising them with plugs from your own wood.

\*Look for more information this fall on [kregtool.com](http://kregtool.com).

**COMING  
SOON!\***

